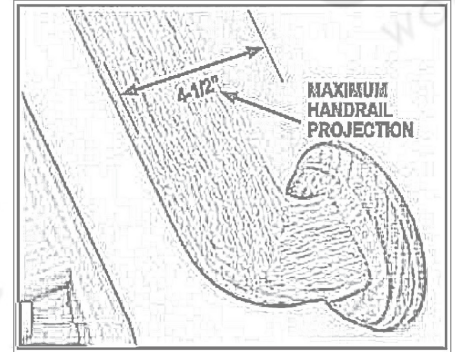


## 2018 RESIDENTIAL STAIR GUIDE

### SECTION R311.7 STAIRWAYS

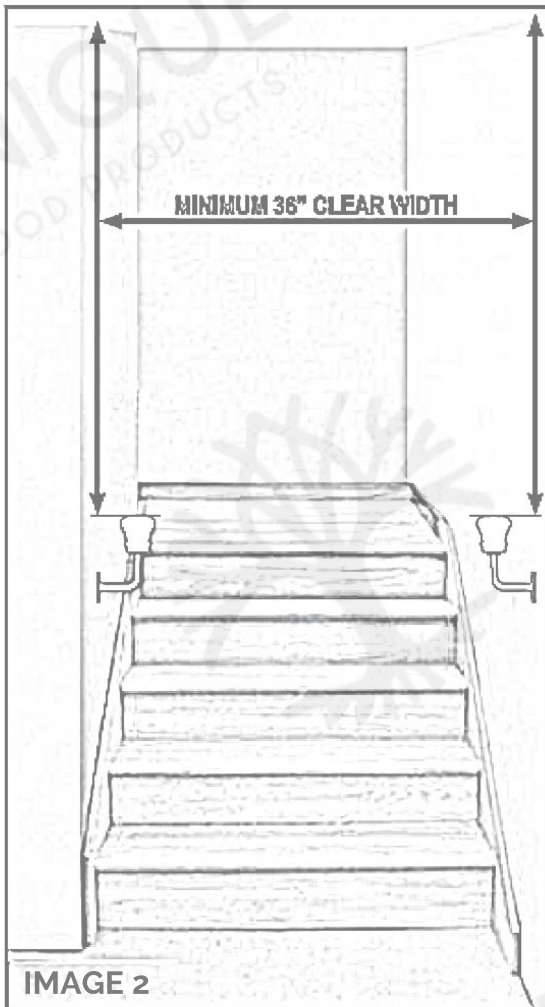
#### R311.7.1 Width.

Stairways shall not be less than 36 inches (914 mm) in clear width at all points above the permitted handrail height and below the required headroom height IMAGE 1. Handrails shall not project more than 4.5 inches (114 mm) on either side of the stairway IMAGE 2 and the minimum clear width of the stairway at and below the handrail height, including treads and landings, shall not be less than 31.5 inches (787 mm) where a handrail is installed on one side and 27 inches (698 mm) where handrails are provided on both IMAGE 3

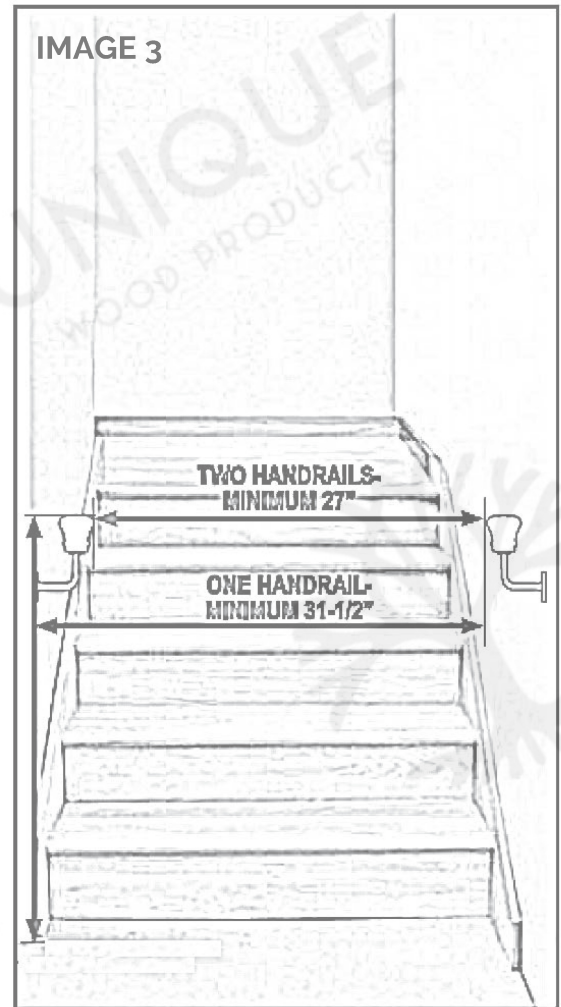


**IMAGE 1**

*Exception:* The width of spiral stairways shall be in accordance with Section R311.7.10.1

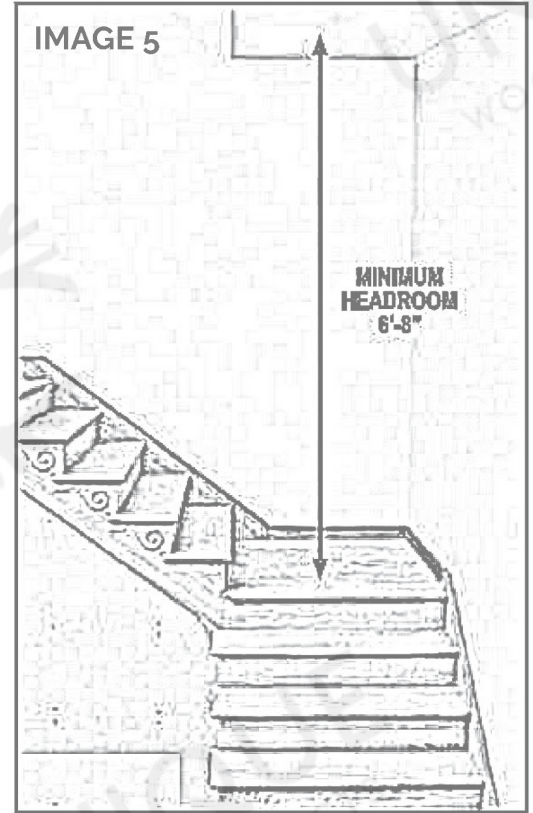
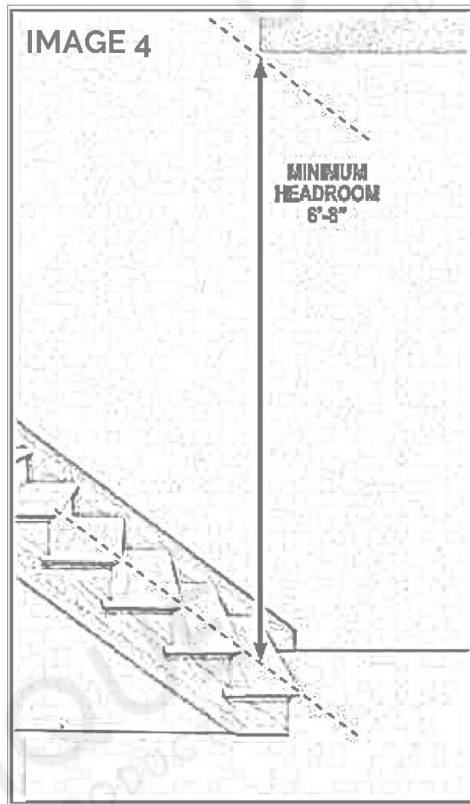


**IMAGE 2**



**IMAGE 3**

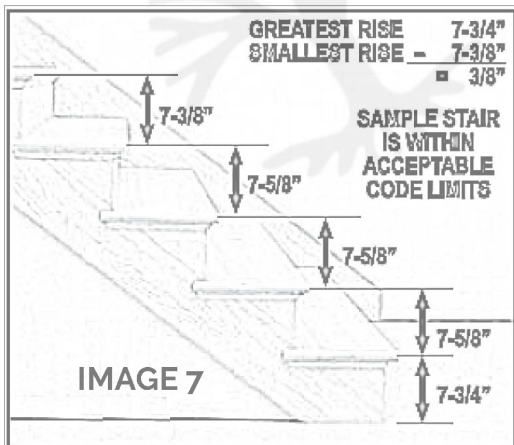
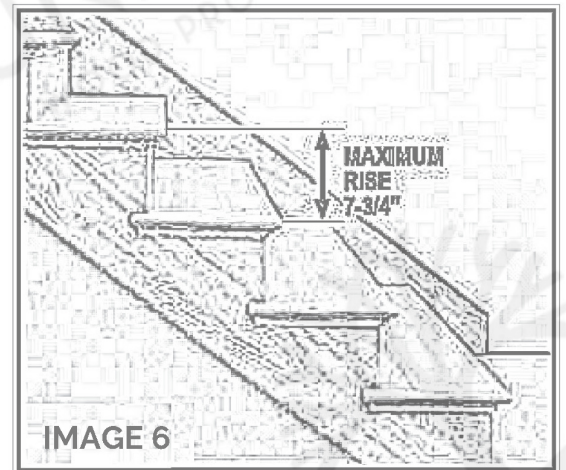
R311.7.2 Headroom. The minimum headroom in all parts of the stairway shall not be less than 6 feet, 8 inches (2036 mm) measured vertically from the sloped plane adjoining the tread nosing IMAGE 4 or from the floor surface of the landing or platform. IMAGE 5



**R311.7.5 Stair treads and risers.**

**R311.7.5.1 Riser height.**

The maximum riser height shall be 7 3/4 inches (196 mm). The riser shall be measured vertically between leading edges of the adjacent treads. IMAGE 6. The greatest riser height within any flight of stairs shall not exceed the smallest by more than 3/8 inch (9.5 mm). IMAGE 7



**R311.7.5.2 Tread depth.**



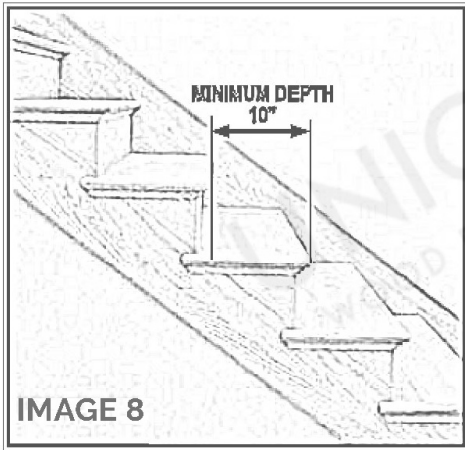


IMAGE 8

The minimum tread depth shall be 10 inches (254 mm). The tread depth shall be measured horizontally between the vertical planes of the foremost projection of adjacent treads and at a right angle to the tread's leading edge. IMAGE 8. The greatest tread depth within any flight of stairs shall not exceed the smallest by more than 3/8 inch (9.5 mm). IMAGE 9.

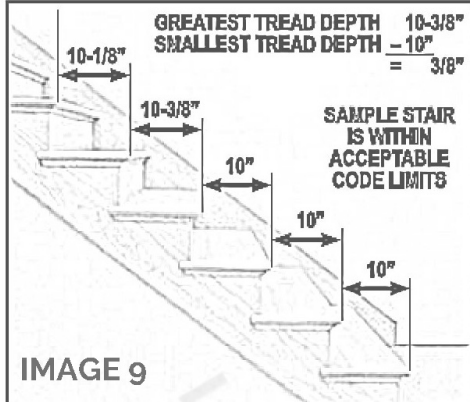


IMAGE 9

**WINDER - A tread with non-parallel edges (as defined in Chapter 2 - IRC, IBC).**

**Winder treads** shall have a minimum tread depth of 10 inches (254 mm) measured as above at a point 12 inches (305 mm) from the side where the treads are narrower. IMAGE 10. Winder treads shall have a minimum tread depth of 6 inches (152 mm) at any point. IMAGE 11. Within any flight of stairs, the greatest winder tread depth at the 12 inch (305 mm) walk line shall not exceed the smallest by more than 3/8 inches (9.5 mm).

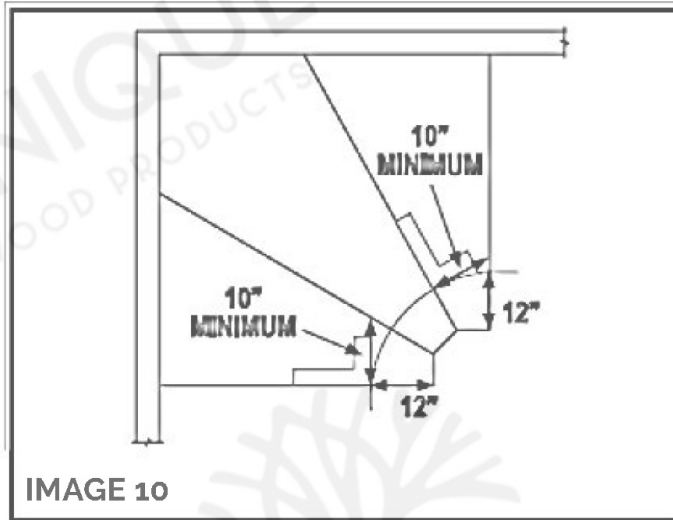


IMAGE 10

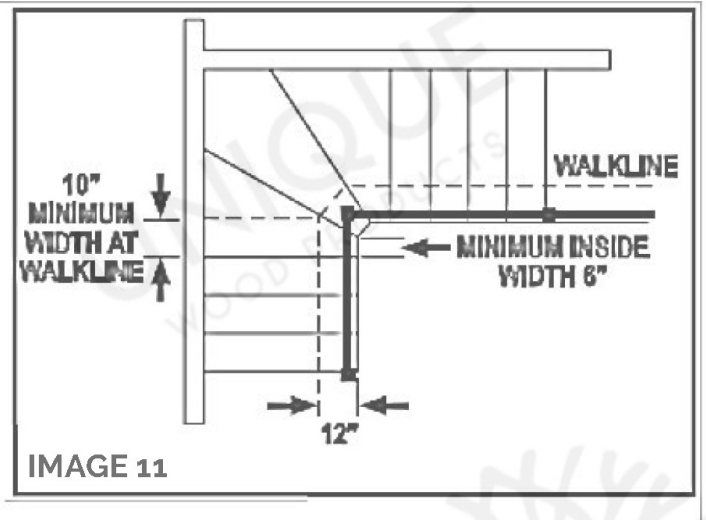
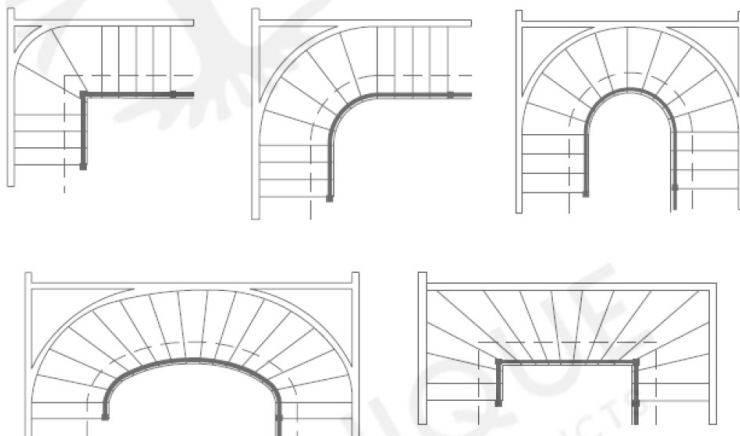


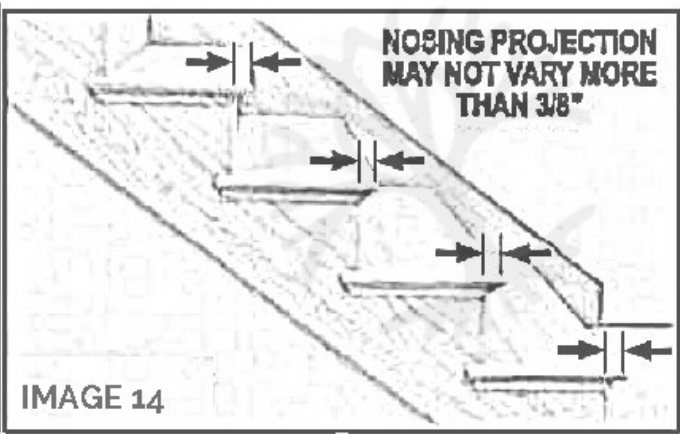
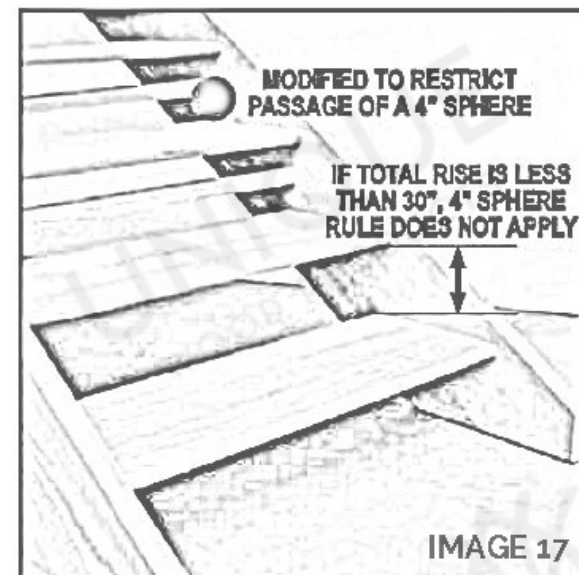
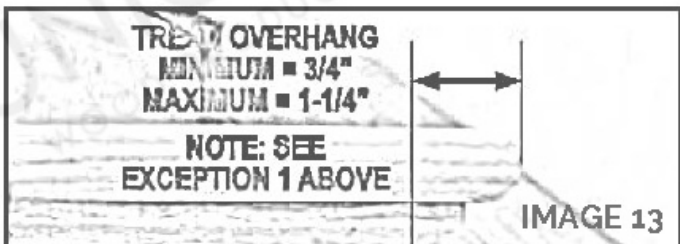
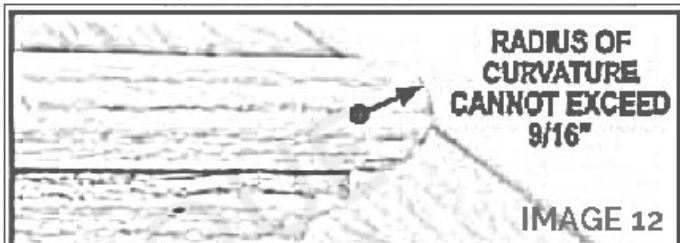
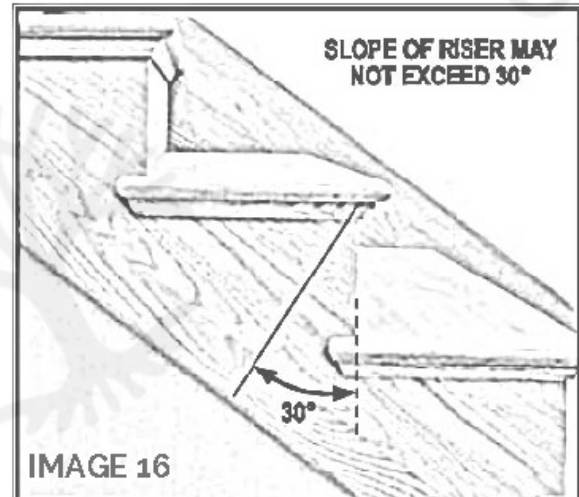
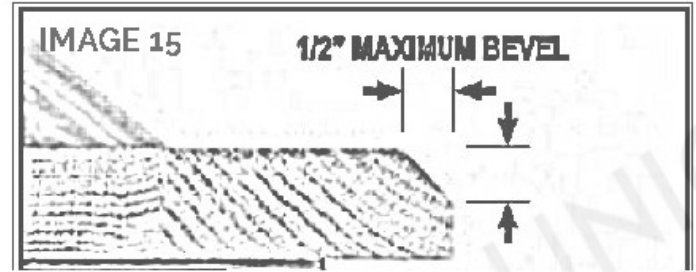
IMAGE 11

ALTERNATE WINDER TREAD DESIGNS

R311.5.3.3



The radius of curvature at the leading edge of the tread shall be no greater than 9/16 inch (14.3 mm). IMAGE 12. A nosing not less than 3/4 inch (19 mm) but not more than 1 1/4 inches (32 mm) shall be provided on stairways with solid risers. IMAGE 13. The greatest nosing projection shall not exceed the smallest nosing projection by more than 3/8 inch (9.5 mm) between two stories, including the nosing at the level of floors and landings. IMAGE 14. Beveling of nosing shall not exceed 1/2 inch (12.7 mm). IMAGE 15. Risers shall be vertical or sloped from the underside of the leading edge of the tread above at an angle not more than 30 (0.51 rad) degrees from the vertical. IMAGE 16. Open risers are permitted, provided that the opening between treads does not permit the passage of a 4-inch diameter (102 mm) sphere. IMAGE 7.



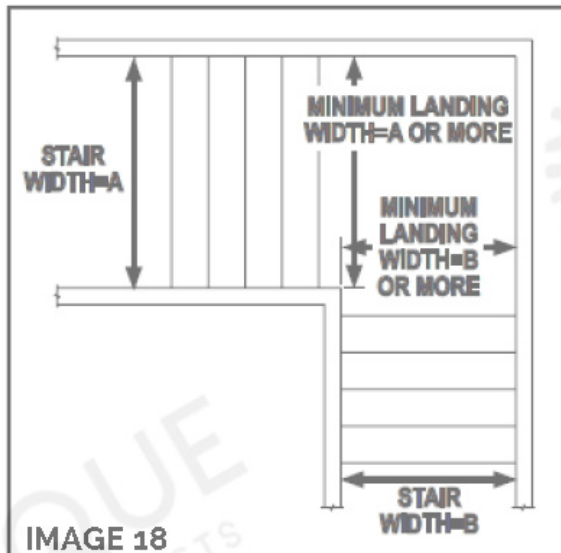
*Exceptions:* 1. a nosing is not required where the tread depth is a minimum of 11 inches (279 mm).  
 2. The opening between adjacent treads is not limited on stairs with a total rise of 30 inches (762 mm) or less. PHOTO 17.  
**R311.7.6 Landings for Stairways.**

There shall be a floor or landing at the top and bottom of each stairway.



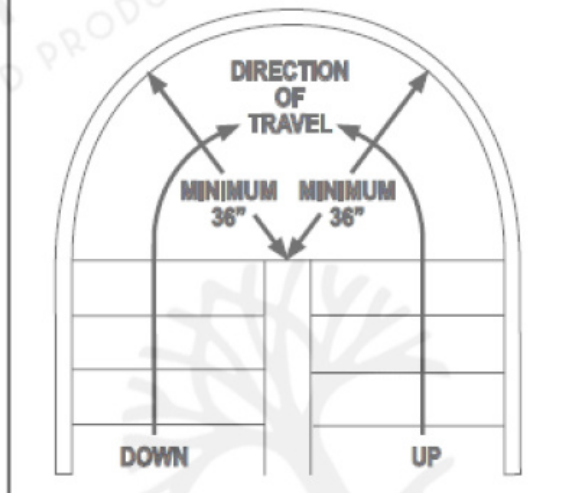
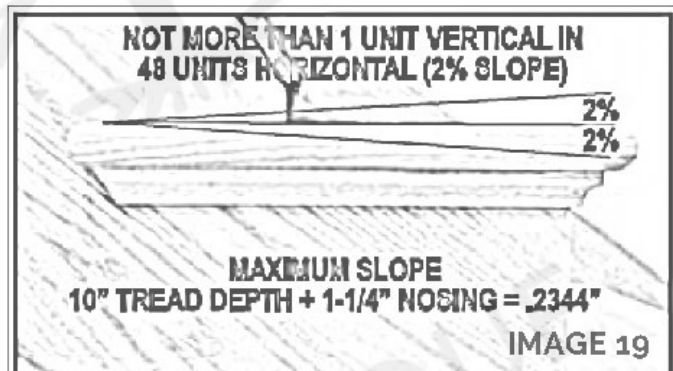
*Exception:* A floor or landing is not required at the top of an interior flight of stairs, including stairs in an enclosed garage, provided a door does not swing over the stairs.

A flight of stairs shall not have a vertical rise greater than 12 feet (3658 mm) between floor levels or landings.  
The width of each landing shall not be less than the stairway served. Every landing shall have a minimum dimension of 36 inches (914 mm) measured in the direction of travel. IMAGE 18.



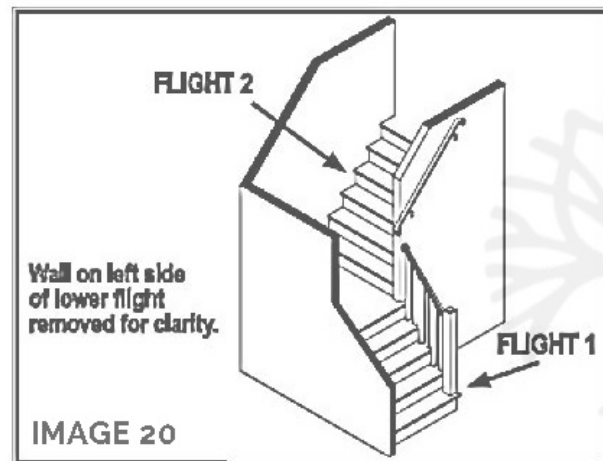
### R311.5.5 Stairway walking surface.

The walking surface of treads and landings of stairways shall be sloped no steeper than one unit vertical in 48 inches horizontal (2-percent slope). IMAGE 19.



### R311.5.6 Handrails.

Handrails shall be provided on at least one side of each continuous run of treads or flight with four or more risers. IMAGE 20.



**R311.5.6.1 Height.** Handrail height, measured vertically from the sloped plane adjoining the tread nosing, or finish surface of ramp slope, shall be not less than 34 inches (864 mm) and not more than 38 inches (965 mm). PHOTO 21.



IMAGE 21

**R311.7.8.4 Continuity.**

Handrails for stairways shall be continuous for the full length of the flight, from a point directly above the top riser of the flight to a point directly above lowest riser of the flight. DRAWING 22 and PHOTO 23. Handrail ends shall be returned PHOTO 24 or shall terminate in newel posts or safety terminals. Handrails adjacent to a wall shall have a space of not less than 1½ inches (38 mm) between the wall and the handrails. PHOTO 25.

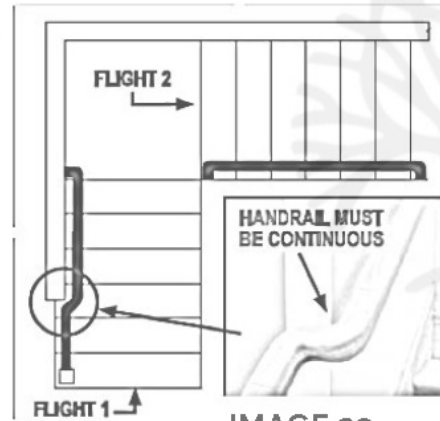


IMAGE 23



IMAGE 24



IMAGE 25

IMAGE 22

*Exceptions:*

1. Handrails shall be permitted to be interrupted by a newel post at the turn. PHOTO 26.
2. The use of a volute, turnout, starting easing or starting newel shall be allowed over the lowest tread. PHOTO 27.

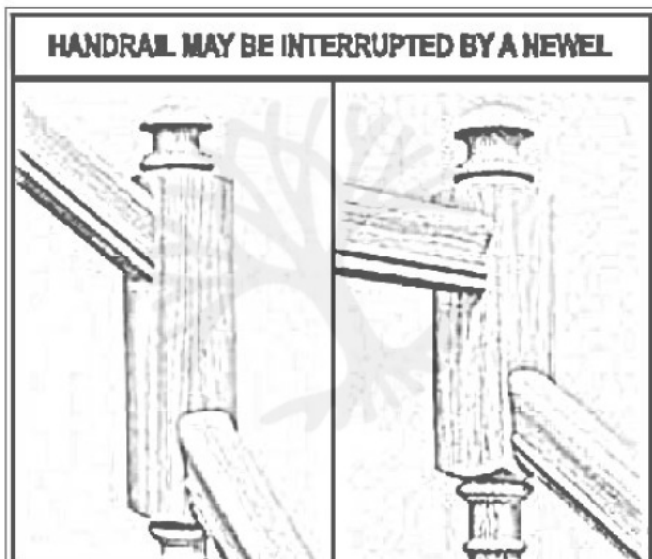


IMAGE 26

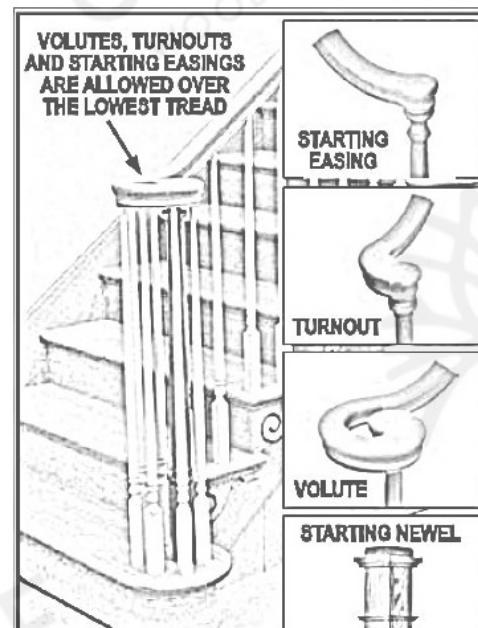


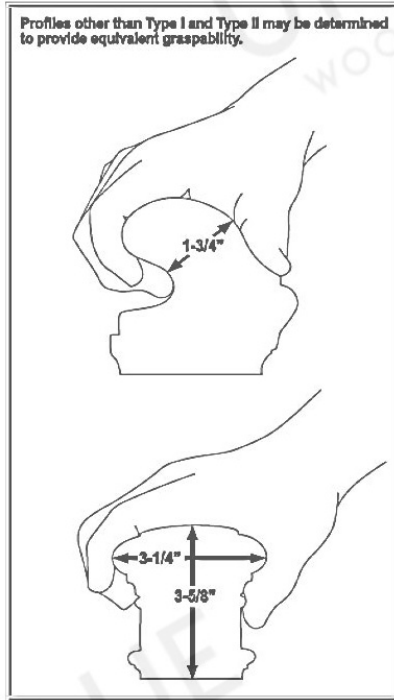
IMAGE 27

Handrail grip size.

R311.7.8.5



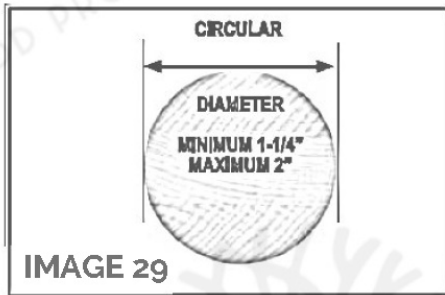
All required handrails shall be of one of the following types or provide equivalent graspability.  
**IMAGE 28.**



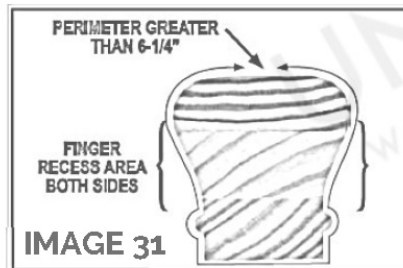
**IMAGE 28**

**1. Type I.** Handrails with a circular cross section shall have an outside diameter of at least 1 1/4 inches (32 mm) and not greater than 2 inches (51 mm). **IMAGE 29.** If the handrail is not circular it shall have a perimeter dimension of at least 4 inches (102 mm) and not greater than 6 1/4 inches (160 mm) with a maximum cross section of dimension of 2 1/4 inches (57 mm). **IMAGE 30.**

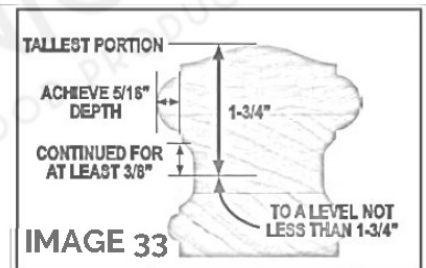
**2. Type II.** Handrails with a perimeter greater than 6 1/4 inches (160mm) shall provide a graspable finger recess area on both sides of the profile. **IMAGE 31.** The finger recess shall begin within a distance of 3/4 inch (19 mm) measured vertically from the tallest portion of the profile and achieve a depth of at least 5/16 inch (8mm) within 7/8 inch (22mm) below the widest portion of the profile. **IMAGE 32.** This required depth shall continue for at least 3/8 inch (10mm) to a level that is not less than 1 3/4 inches (45 mm) below the tallest portion of the profile. **IMAGE 33.** The minimum width of the handrail above the recess shall be 1 1/4 inches (32 mm) to a maximum of 2 3/4 inches (70 mm). **IMAGE 34.** Edges shall have a minimum radius of 0.01 inches (0.25 mm). **IMAGE 34**



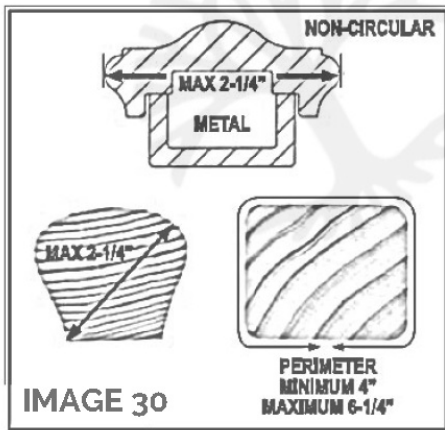
**IMAGE 29**



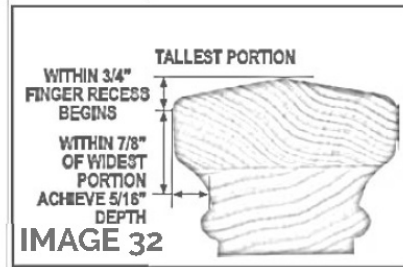
**IMAGE 31**



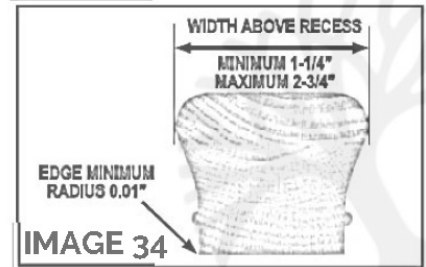
**IMAGE 33**



**IMAGE 30**



**IMAGE 32**



**IMAGE 34**

All stairs shall be provided with illumination in accordance with Section R303.6.

**R311.5.7 Illumination.**

**R311.7.10 Special stairways.**

Circular stairways, spiral stairways, winders and bulkhead enclosure stairways shall comply with all requirements of Section R311.5 except as specified below.

### R311.7.10.1 Spiral Stairs.

Spiral stairways are permitted, provided the minimum width shall be 26 inches (660 mm) with each tread having a 7 1/2 inch (190 mm) minimum tread depth at 12 inches from the narrower edge. All treads shall be identical, and the rise shall be no more than 9 1/2 inches (241 mm). A minimum headroom of 6 feet, 6 inches (1982 mm) shall be provided. IMAGE 35

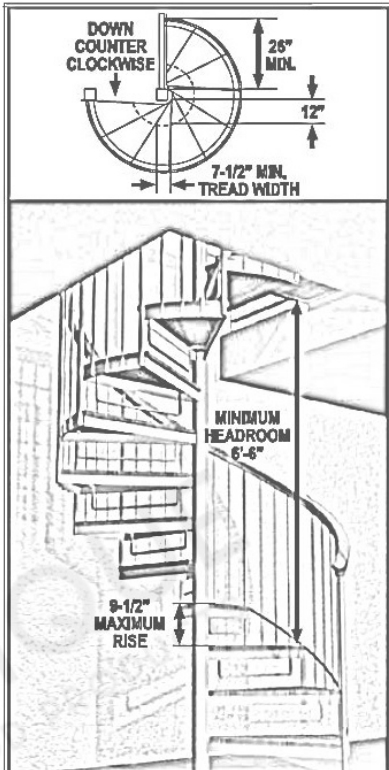


IMAGE 35

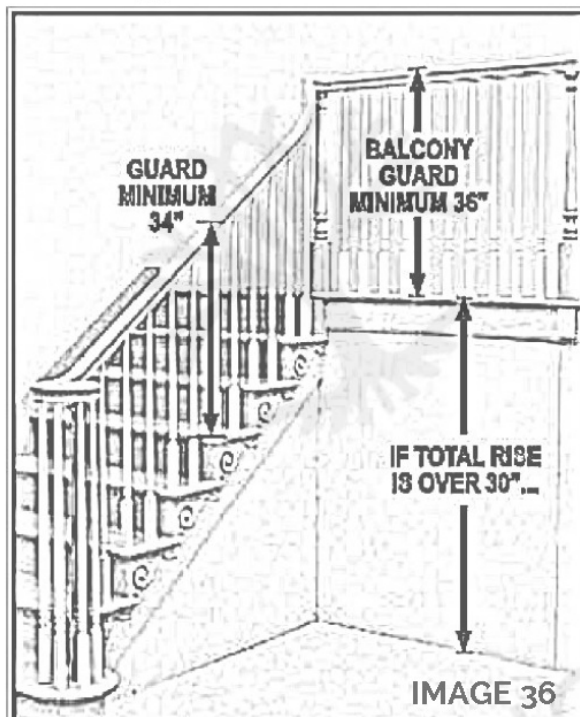


IMAGE 36

### R311.7.10.2 Bulkhead enclosure stairways.

Stairways serving bulkhead enclosures, not part of the required building egress, providing access from the outside grade level to the basement shall be exempt from the requirements of Sections R311.3 and R311.7 where the maximum height from the basement finished floor level to grade adjacent to the stairway does not exceed 8 feet (2438 mm), and the grade level opening to the stairway is covered by a bulkhead enclosure with hinged doors or other approved means.

## SECTION R312 GUARDS

### R312.1 Guards.

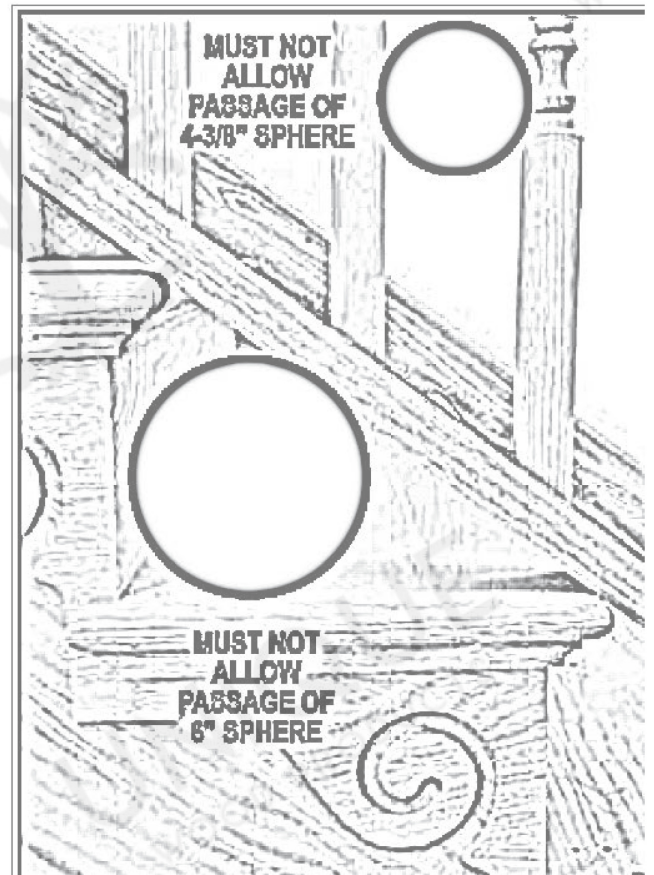
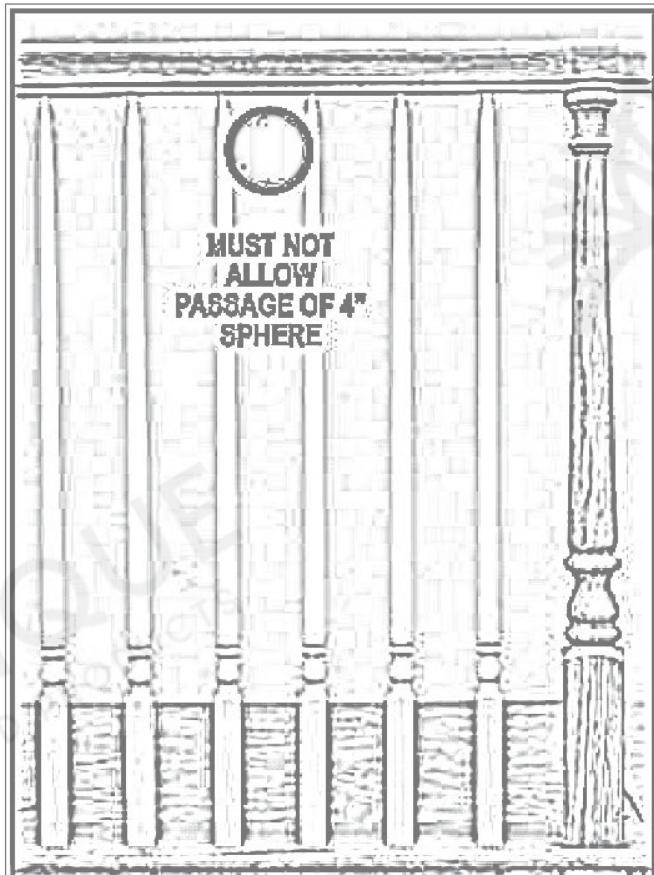
Porches, balconies, ramps or raised floor surfaces located more than 30 inches (762 mm) above the floor or grade below shall have guards not less than 36 inches (914 mm) in height. Open sides of stairs with a total rise of more than 30 inches (762 mm) above the floor or grade below shall have guards not less than 34 inches (864 mm) in height measured vertically from the nosing of the treads. IMAGE 36.

Porches and decks which are enclosed with insect screening shall be equipped with guards where the walking surface is located more than 30 inches (762 mm) above the floor or grade below.



### R312.1.3 Opening Limitations.

Required guards on open sides of stairways, raised floor areas, balconies and porches shall have intermediate rails or ornamental closures which do not allow passage of a sphere 4 inches (102 mm) or more in diameter. IMAGE 37



#### Exception:

1. The triangular openings formed by the riser, tread and bottom rail of a guard at the open side of a stairway are permitted to be of such a size that a sphere 6 inches (152 mm) cannot pass through. IMAGE 38.
2. Openings for required guards on the sides of stair treads shall not allow a sphere 4 3/8 inches (107 mm) to pass through IMAGE 38.



**UNIQUE**  
- WOOD PRODUCTS -