

UNIQUE

WOOD PRODUCTS

STAIR CATALOGUE

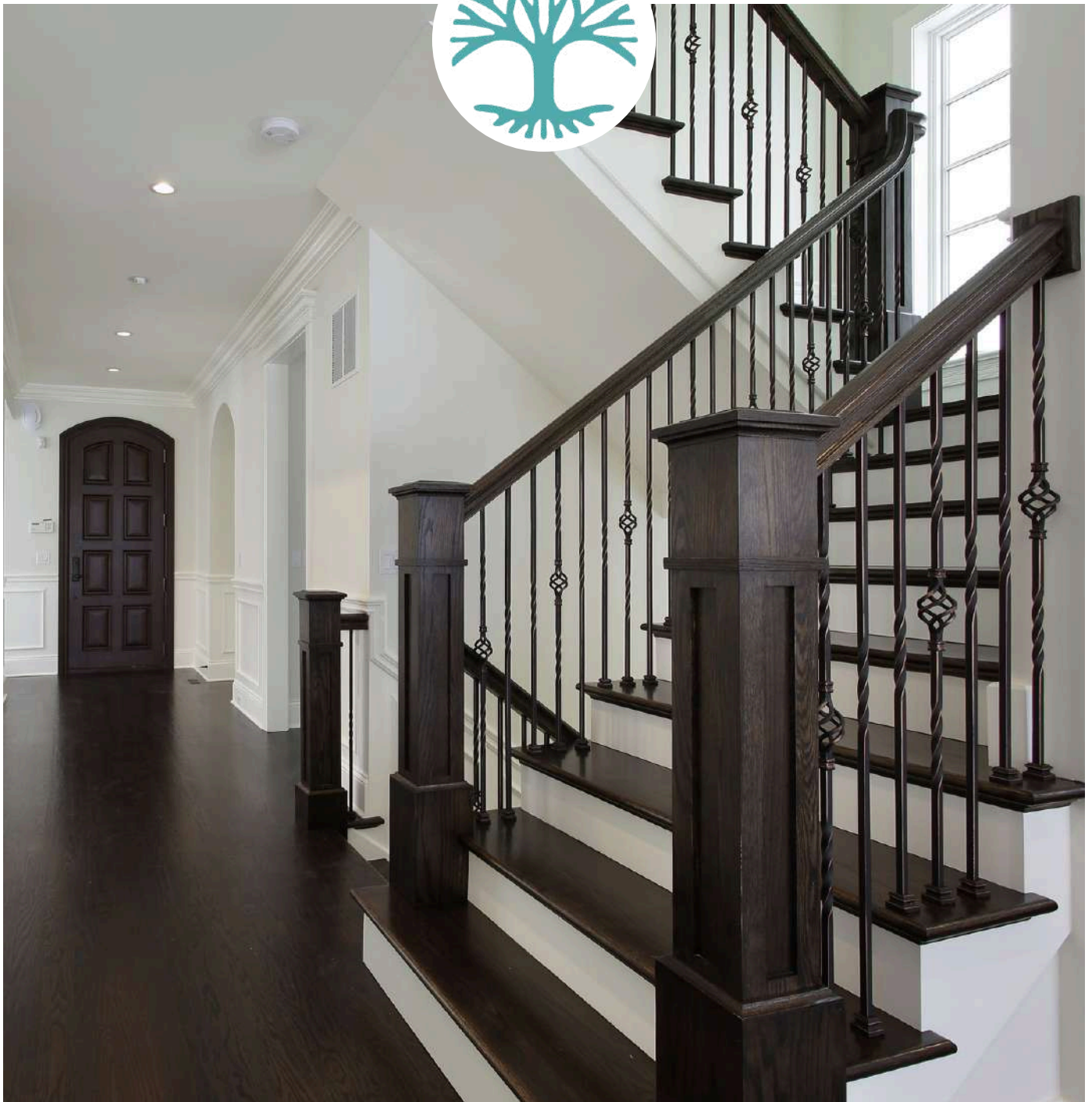

TABLE OF _____ CONTENTS

01 | IRON BALUSTERS
Page 6

02 | IRON NEWELS
Page 15

03 | IRON ACCESSORIES
Page 18

04 | WOOD BALUSTERS
Page 19

05 | WOOD NEWELS
Page 26

06 | HANDRAILS
Page 28

07 | HANDRAILS FITTINGS
Page 32

08 | WOOD ACCESSORIES
Page 35

09 | TREADS
Page 36

10 | RISERS
Page 42

11 | STARTING STEPS
Page 43

12 | CUSTOM STAIR PORTFOLIO
Page 54



WE ARE
UNIQUE.

excellence

INTEGRITY



UNIQUE
- WOOD PRODUCTS -

We are a trusted millwork partner dedicated to helping you create a truly remarkable home.

Unique Wood Products manufactures and distributes high quality architectural products that turn houses into your homes.

OUR MISSION

At Unique Wood Products, our mission is to surpass our clients' needs and expectations by consistently delivering high-quality products and solutions with care and respect. We are committed to building strong, honest relationships, providing exceptional service, and fostering lasting trust with our clients.



HONESTY | RELIABILITY | PROFESSIONALISM | INTEGRITY

Standard Iron and Wood Finishes

**SATIN
BLACK**



**ANTIQUÉ
BRONZE**



**OIL RUBBED
BRONZE**



**OIL RUBBED
COPPER**



SILVER VEIN



Color keys are for ease of ordering like finished parts only, and are not meant to be representational.

RED OAK



(O) & (RO)

WHITE OAK

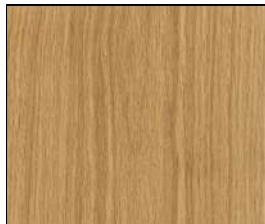

(WO)

HICKORY/ PECAN



(HK)

MAPLE



(M) & (MP)

POPLAR



(P) & (POP)

HEMLOCK

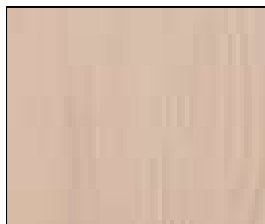

(H)

PRIMED

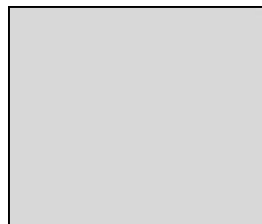

(PR)

YELLOW PINE



(YP)

Color keys are for ease of ordering like finished parts only, and are not meant to be representational.

With a full in-house millwork facility, we can manufacture wood products in a variety of wood species, many not listed above.

Iron Balusters

Star Design

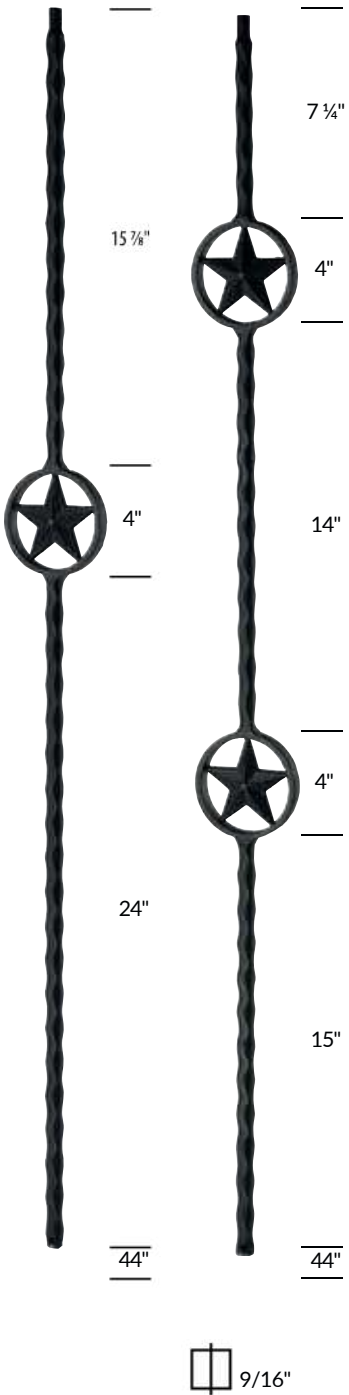

MODEL #	SKU #	MODEL #	SKU #
S-M673SB	1035550	S-M674SB	1035551

Contemporary Balusters

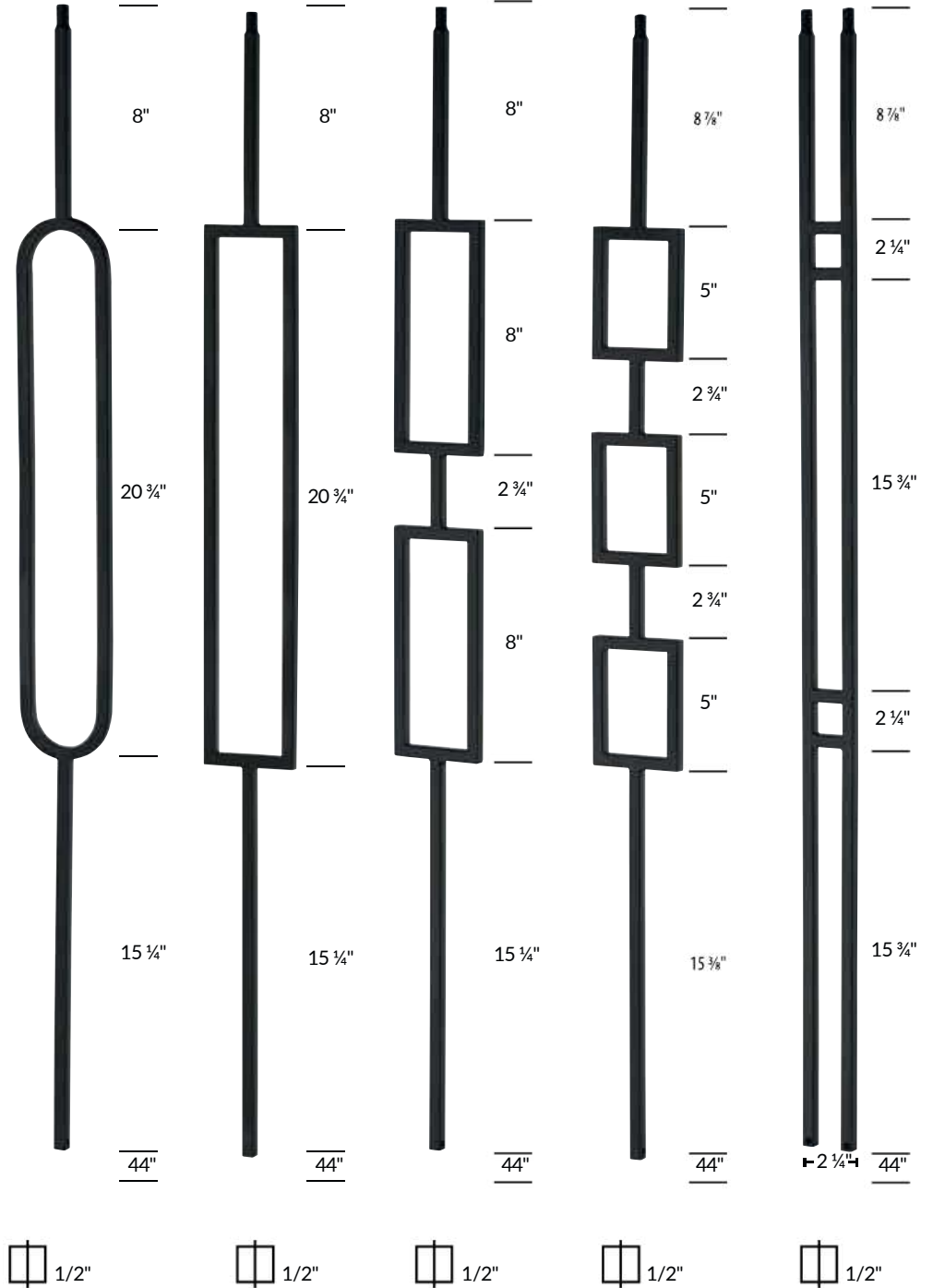

MODEL #	SKU #	MODEL #	SKU #	MODEL #	SKU #	MODEL #	SKU #	MODEL #	SKU #
S-M300SB	1035256	S-M301SB	1035264	S-M302SB	1035266	S-M303SB	1035268	S-M304SB	1035279

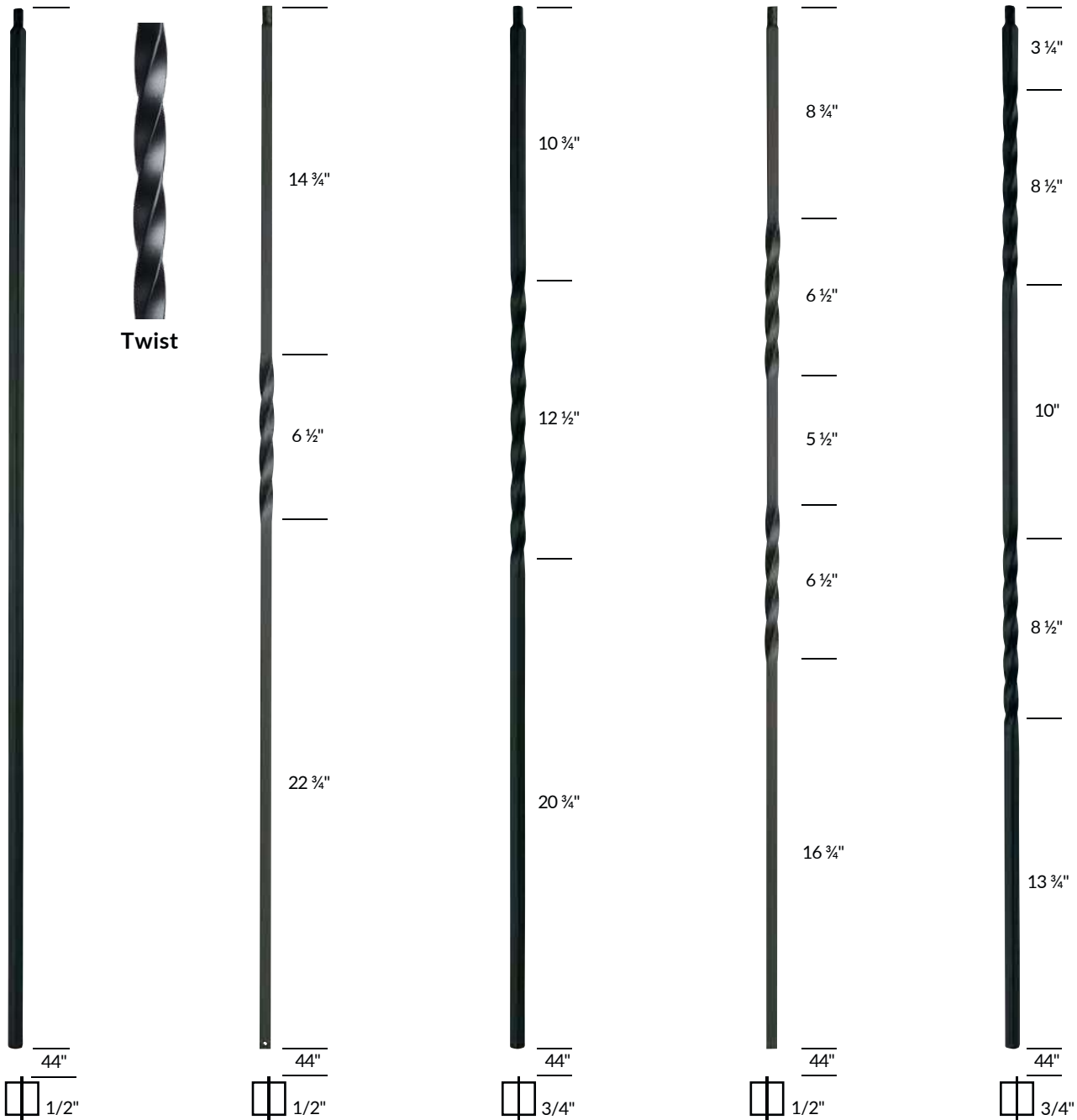

Twist

MODEL #	SKU #
S-M701SB	1036805
S-M701AB	1036789
S-M701ORB	1036795
S-M701ORC	1036797
S-M701PC	1036801

MODEL #	SKU #
S-MC658SB	1038333
S-MC658AB	1038324
S-MC658ORB	1038327
S-MC658ORC	1038329
S-MC658PC	1038331

MODEL #	SKU #
S-MXL658SB	1037093
S-MXL658ORB	1037087
S-MXL658ORC	1037089

MODEL #	SKU #
S-MC533SB	1038322
S-MC533AB	1038312
S-MC533ORB	1038315
S-MC533ORC	1038317
S-MC533PC	1038320

MODEL #	SKU #
S-MXL533SB	1037084
S-MXL533ORB	1037078
S-MXL533ORC	1037080

MODEL #	SKU #
S-MXL701SB	1037102
S-MXL701ORB	1037096
S-MXL701ORC	1037098

Iron Balusters

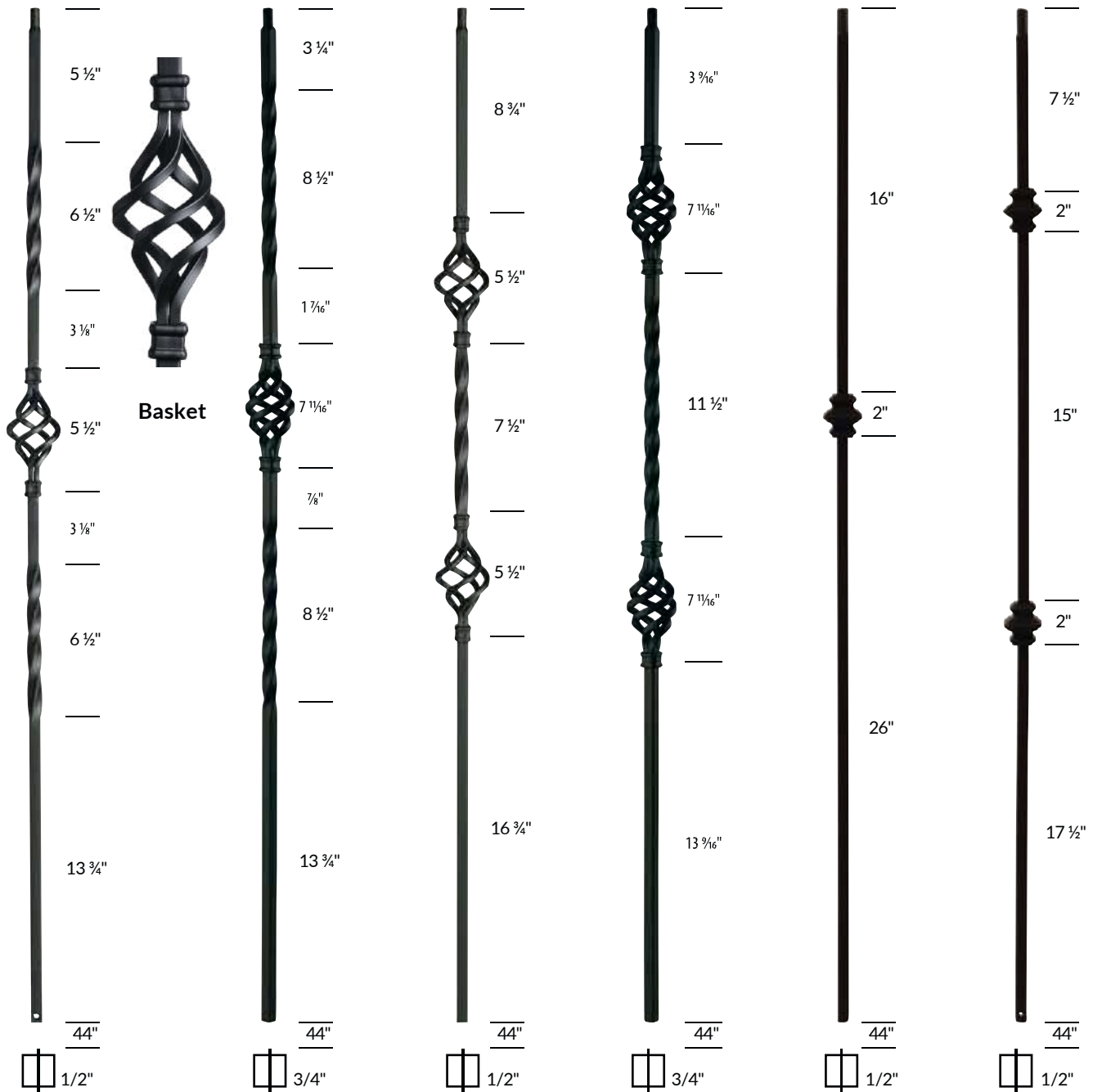

MODEL #	SKU #
S-MC482SB	1038311
S-MC482AB	1038302
S-MC482ORB	1038305
S-MC482ORC	1038307
S-MC482PC	1038309

MODEL #	SKU #
S-MXL482SB	1037058
S-MXL482ORB	1037051
S-MXL482ORC	1037053

MODEL #	SKU #
S-MC481SB	1038301
S-MC481AB	1038291
S-MC481ORB	1038294
S-MC481ORC	1038296
S-MC481PC	1038299

MODEL #	SKU #
S-MXL481SB	1037048
S-MXL481ORB	1037043
S-MXL481ORC	1037045

MODEL #	SKU #
S-M671SB	1035543
S-M671ORB	1035539

MODEL #	SKU #
S-M672SB	1035549
S-M672ORB	1035544

Iron Balusters

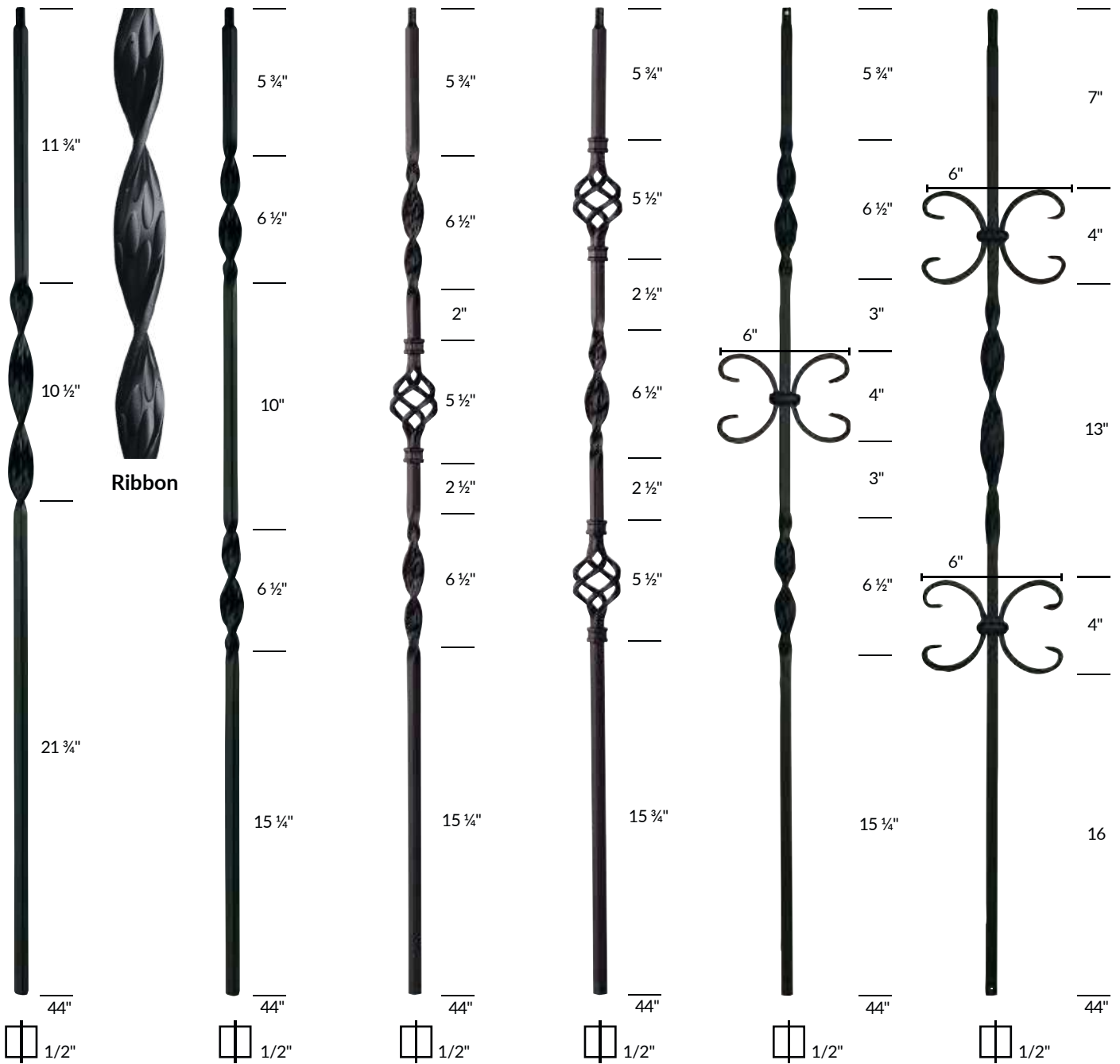

MODEL #	SKU #
S-M505SB	1036704
S-M505AB	1036692
S-M505ORB	1036696
S-M505ORC	1036698

MODEL #	SKU #
S-M506SB	1036728
S-M506AB	1036715
S-M506ORB	1036719
S-M506ORC	1036721

MODEL #	SKU #
S-MC782SB	1038348
S-MC782ORB	1038342
S-MC782ORC	1038344

MODEL #	SKU #
S-MC781SB	1038341
S-MC781ORB	1038335
S-MC781ORC	1038337

MODEL #	SKU #
S-M742SB	1035566
S-M742ORB	1035557
S-M742ORC	1035559

MODEL #	SKU #
S-M741SB	1038205
S-M741ORB	1038195
S-M741ORC	1038197

MODEL #	SKU #
S-MXL505SB	1037067
S-MXL505ORB	1037062
S-MXL505ORC	1037064

MODEL #	SKU #
S-MXL506SB	1037075
S-MXL506ORB	1037070
S-MXL506ORC	1037072

Iron Balusters



44"

44"

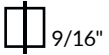

9/16"

MODEL #	SKU #
S-M703SB	1036828
S-M703ORB	1036822
S-M703ORC	1036824



Hammered Face



12"

5 1/2"

1"

5 1/2"

20"

44"

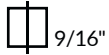

9/16"

MODEL #	SKU #
S-M644SB	1035479
S-M644ORB	1035473
S-M644ORC	1035475



5 1/2"

5 1/2"

1"

12"

1"

5 1/2"

13 1/2"

44"

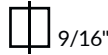

9/16"

MODEL #	SKU #
S-M645SB	1035488
S-M645ORB	1035482
S-M645ORC	1035484



9 15/16"

5 1/2"

5 1/8"

5 1/2"

17 15/16"

44"



9 15/16"

MODEL #	SKU #
S-M646SB	1035494
S-M646ORB	1035490
S-M646ORC	1035492

Hammered Edge

44"

9/16"

MODEL #	SKU #
S-M704SB	1036841
S-M704ORB	1036839

Sphere

18 3/4"

2"

23 1/4"

44"

9/16"

MODEL #	SKU #
S-M455SB	1035370
S-M455AB	1035367
S-M455ORB	1035368

Sphere

9 1/8"

2"

17 3/8"

2"

13 1/2"

44"

9/16"

MODEL #	SKU #
S-M456SB	1035375
S-M456AB	1035372
S-M456ORB	1035373

Decorative Scroll

12 5/8"

2"

14"

5"

17 3/8"

44"

9/16"

MODEL #	SKU #
S-M454SB	1035365
S-M454AB	1035362
S-M454ORB	1035363

Iron Balusters

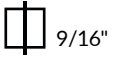

MODEL #	SKU #
S-M457SB	1035378
S-M457ORB	1035376

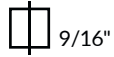

MODEL #	SKU #
S-M458SB	1035381
S-M458ORB	1035379

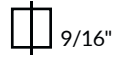

MODEL #	SKU #
S-M453SB	1035361
S-M453ORB	1035359

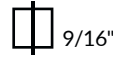

MODEL #	SKU #
S-M652SB	1035505
S-M652ORB	1035503

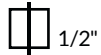
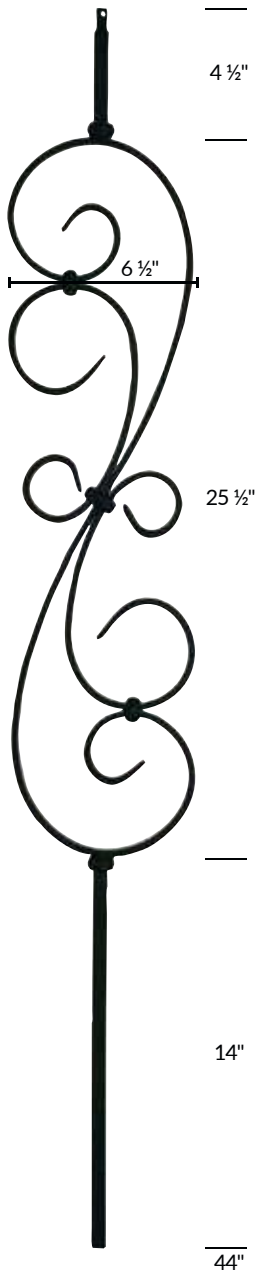

MODEL #	SKU #
S-M452SB	1035357
S-M452AB	1035345
S-M452ORB	1035349
S-M452ORC	1035351

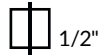
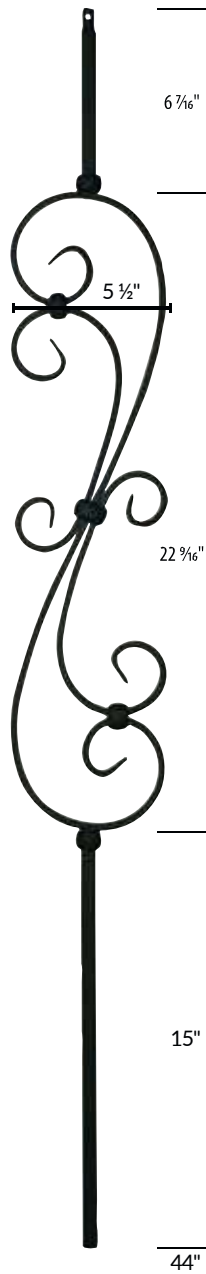

MODEL #	SKU #
S-M451SB	1035341
S-M451AB	1035328
S-M451ORB	1035334
S-M451ORC	1035336
S-M451PC	1035339

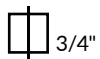

MODEL #	SKU #
S-MXL451SB	1037036
S-MXL451ORB	1037032
S-MXL451ORC	1037034



MODEL #	SKU #
S-M651SB	1035502
S-M651ORB	1035499

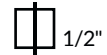

MODEL #	SKU #
S-M752SB	1035578
S-M752ORB	1035570
S-M752ORC	1035572

Iron Balusters

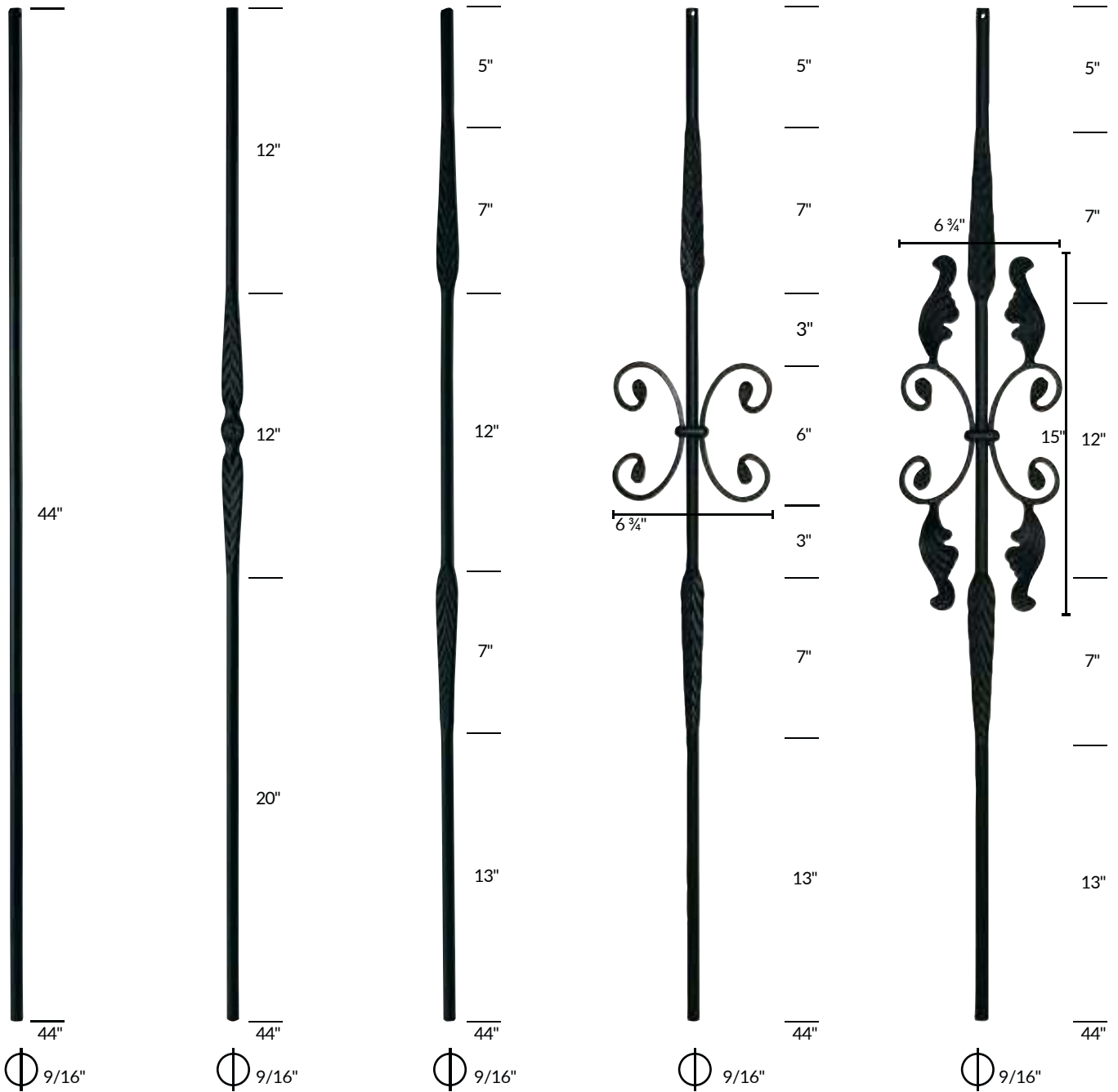

MODEL #	SKU #
S-M702SB	1036815
S-M702ORB	1036811

MODEL #	SKU #
S-M705SB	1036849
S-M705ORB	1036845

MODEL #	SKU #
S-M706SB	1036858
S-M706ORB	1036854

MODEL #	SKU #
S-M707SB	1036867
S-M707ORB	1036863

MODEL #	SKU #
S-M708SB	1036881
S-M708ORB	1036877

⊙ Round Shaft



 1-3/16"

MODEL #	SKU #
S-M1131SB	1036574
S-M1131ORB	1036571



 1-3/16"

MODEL #	SKU #
S-M1132SB	1036590
S-M1132AB	1036576



 1-3/16"

MODEL #	SKU #
S-M1138SB	1036613
S-M1138ORB	1036606



 1-3/16"

MODEL #	SKU #
S-M1136SB	1036600
S-M1136ORB	1036595

Iron Newels

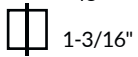

MODEL #	SKU #
S-M1139SB	1036616
S-M1139ORB	1036614

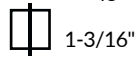

MODEL #	SKU #
S-M640SB	1035463

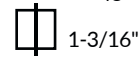

MODEL #	SKU #
S-M1140SB	1035234

Flat Shoes



1/2" CENTER	
MODEL #	SKU #
S-06SB	1033963
S-06AB	1033927
S-06ORB	1033953
S-06ORC	1033955
S-06PC	1033959



S-M799 | 9/16" Round Center Baluster Flat Shoe

MODEL #	SKU #
S-M799SB	1036968
S-M799ORB	1036964



Baluster Flat Shoe

3/4" CENTER	
MODEL #	SKU #
S-XL06SB	1038125
S-XL06ORB	1038120
S-XL06ORC	1038122

9/16" CENTER	
MODEL #	SKU #
S-07SB	1033972
S-07ORB	1033967
S-07ORC	1033969



Baluster Flat Shoe

1/2" CENTER	
MODEL #	SKU #
LI-ALSQPL1-LSB	4110141



S-M797 | 1/2" Center Baluster Flat Shoe

1/2" CENTER	
MODEL #	SKU #
S-M797SB	1036946
S-M797ORB	1036940



S-M020 | 1/2" Center Baluster Shoe

MODEL #	SKU #
S-M020-SB	1036568
S-M020-AB	1036552
S-M020-ORB	1036560
S-M020-ORC	1036562

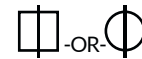

MODEL #	SKU #
S-M020-SP	1036570

Baluster Shoe-plastic Black Synthetic

Adjustable Center 1/2" To 9/16" Round Or Square Center



S-MRD201 Baluster Shoe Adjustable Center 1/2" To 9/16" Round Or Square Center

MODEL #	SKU #
S-MRD201-SB	1037006
S-MRD201-ORB	1038364
S-MRD201-ORC	1037000



S-M202 | 1/2" Center 2" X 2" Flat Retro Shoe

MODEL #	SKU #
S-M202-SB	1035239
S-M202-ORB	1035235



Square Shaft



Round Shaft

Iron Accessories

Rake Shoes



1/2" CENTER	
MODEL #	SKU #
S-02SB	1033916
S-02AB	1033904
S-02ORB	1040102
S-02ORC	1033910
S-02PC	1033914

3/4" CENTER	
MODEL #	SKU #
S-XL02SB	1038117
S-XL02ORB	1038112
S-XL02ORC	1038114

9/16" CENTER	
MODEL #	SKU #
S-03SB	1033925
S-03AB	1033918
S-03ORB	1033919
S-03ORC	1033921



Baluster Rake Shoe



S-M792 | 9/16" Round Center Baluster Rake Shoe

MODEL #	SKU #
S-M792SB	1036921
S-M792ORB	1035633

Knuckles



Square Center Knuckle

1/2" CENTER	
MODEL #	SKU #
S-M798SB	1036958
S-M798AB	1036947
S-M798ORB	1036951
S-M798ORC	1036953

3/4" CENTER	
MODEL #	SKU #
S-MXL798SB	1037124
S-MXL798ORB	1037118
S-MXL798ORC	1037120

Newel Hardware



S-06N | 1 1/4" Center Newel Flat Shoe

MODEL #	SKU #
S-06NSB	1033947
S-06NAB	1033933
S-06NORB	1033941



S-MB Metal Newel Fastener

MODEL #	SKU #
S-MB	1038289

Epoxy

MODEL #	SKU #	
2 Part	103475	Epoxy only
Epoxy		



Baluster Fasteners



For Use With 1/2" Hollow Square Iron Balusters On Open Tread Stairs, Kneewall Stairs And Level Runs.

MODEL #	SKU #
LIH-HOL1/2CONCEAL	4000179

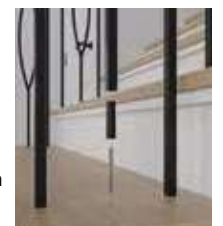

For Use With 1/2" Hollow Square Iron Balusters On Open Tread Stairs And Level Runs.

MODEL #	SKU #
LIH-HOLINSERTW/SCREW	4300393

Wood Balusters



MODEL #	(L)	SKU #
PRIMED		
SW-PR5005-36	36"	1039423
SW-PR5005-42	42"	1039424



MODEL #	(L)	SKU #
PRIMED		
SW-PR5200-41	41"	1039456



MODEL #	(L)	SKU #
PRIMED		
SW-PR5090-36	36"	1039447
SW-PR5090-42	42"	1039448

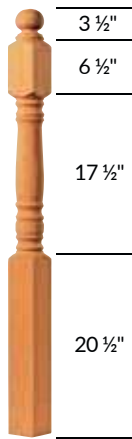

Starting Newel

MODEL #	(L)	SKU #
OAK		
S-4500	48"	1034134

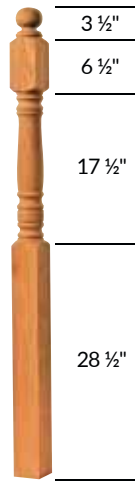

Landing Newel

MODEL #	(L)	SKU #
OAK		
S-4504	56"	1034138

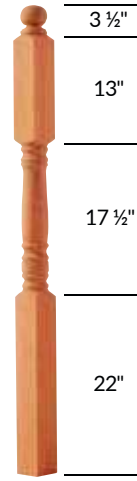

Landing Newel

MODEL #	(L)	SKU #
OAK		
S-4505	56"	1034141

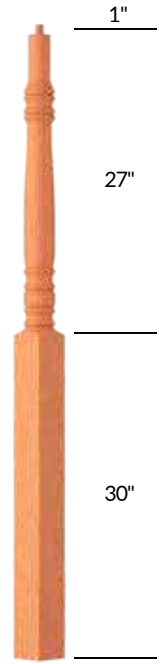

Landing Newel

MODEL #	(L)	SKU #
OAK		
S-4275	58"	1034127

Wood Balusters

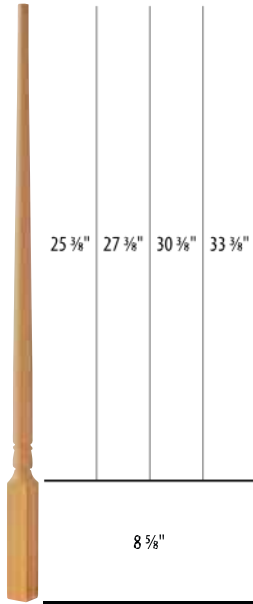

MODEL #	(L)	SKU #
POPLAR		
SW-P5315-34	34"	1039359
SW-P5315-36	36"	1039360
SW-P5315-39	39"	1039361
SW-P5315-42	42"	1039362

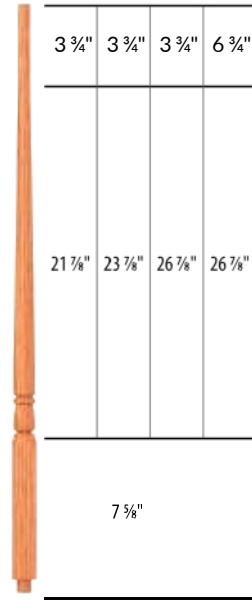

MODEL #	(L)	SKU #
OAK		
S-5015-34	34"	1032861
S-5015-36	36"	1032862
S-5015-39	39"	1032863
S-5015-42	42"	1032864

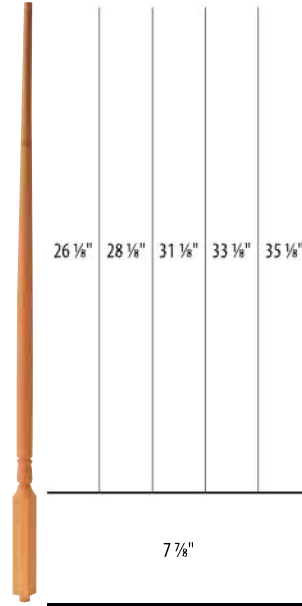

MODEL #	(L)	SKU #
WHITE OAK		
S-WO4010	43"	1043574

MODEL #	(L)	SKU #
PRIMED		
SW-PR5015-34	34"	1039426
SW-PR5015-36	36"	1039428
SW-PR5015-39	39"	1039430
SW-PR5015-41	41"	1039432
SW-PR5015-43	43"	1039436

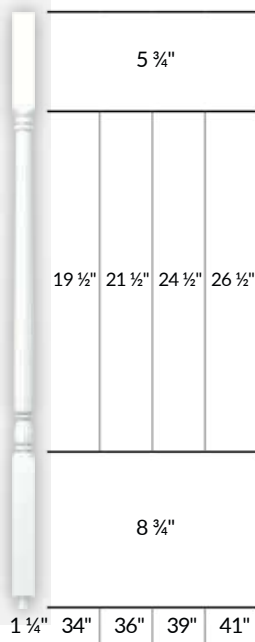

MODEL #	(L)	SKU #
PRIMED		
SW-PR5141-34	34"	1039450
SW-PR5141-36	36"	1039451
SW-PR5141-39	39"	1039452
SW-PR5141-41	41"	1039453

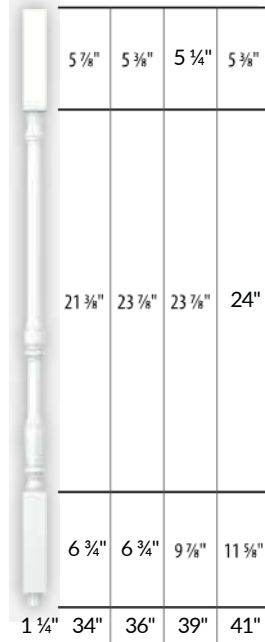

MODEL #	(L)	SKU #
PRIMED		
SW-PR5067-34	34"	1039442
SW-PR5067-36	36"	1039443
SW-PR5067-39	39"	1039444
SW-PR5067-41	41"	1039445



MODEL #	(L)	SKU #
OAK		
S-4010	43"	1032830
WHITE OAK		
S-WO4010	43"	1043574

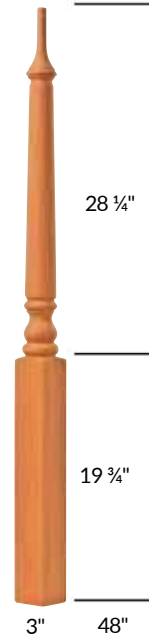

MODEL #	(L)	SKU #
OAK		
S-4010RK	48"	1032831

Wood Balusters

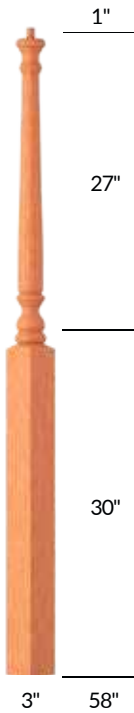

Landing Newel

MODEL #	(L)	SKU #
OAK		
S-4015	58"	1032839



Starting Newel

MODEL #	(L)	SKU #
OAK		
S-4040	47-5/8"	1032841
S-4040H	48"	1032847

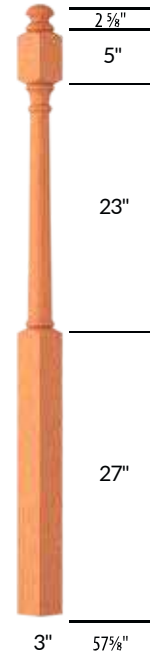

Starting Newel

MODEL #	(L)	SKU #
OAK		
S-4042	57-5/8"	1034047
WHITE OAK		
S-WO4042	54"	1043575



Landing Newel

MODEL #	(L)	SKU #
OAK		
S-4045	57-5/8"	1034051
WHITE OAK		
S-WO4045	62"	1043576

MODEL #	(L)	SKU #
OAK		
S-4046	62"	1034055
S-4055	72-5/8"	1034061

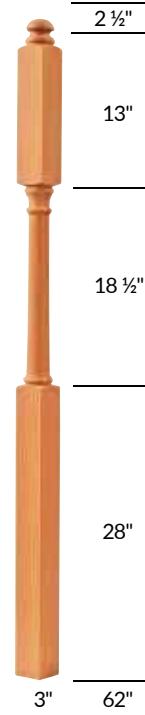

Landing Newel

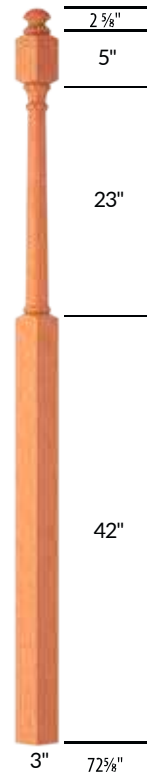

Landing Newel

Wood Balusters



MODEL #	(L)	SKU #
OAK		
S-5342-42	42"	1032907

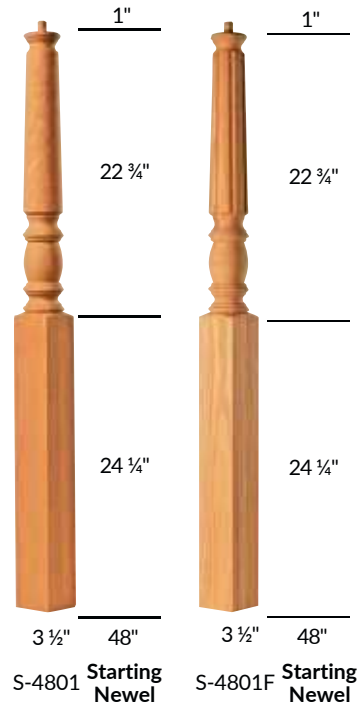

MODEL #	(L)	SKU #
OAK		
S-4801	48"	1034161
S-4801F	48"	1034163

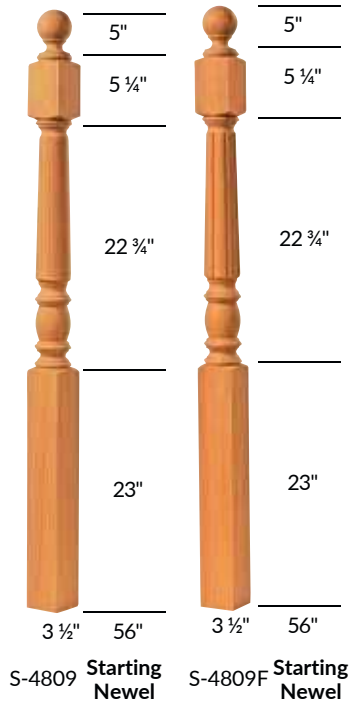

MODEL #	(L)	SKU #
OAK		
S-4809	56"	1034175
S-4809F	56"	1034176

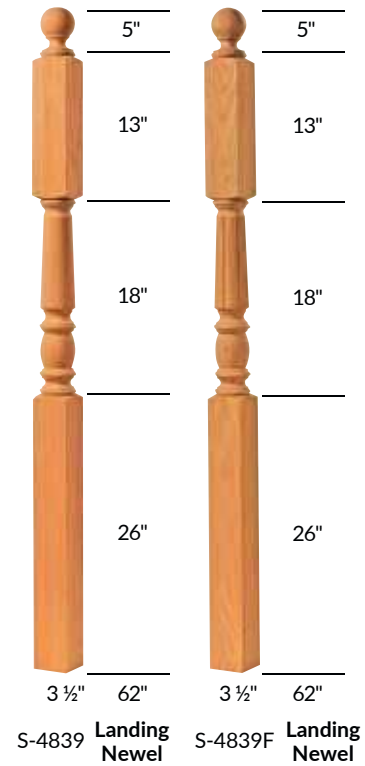

MODEL #	(L)	SKU #
OAK		
S-4839	62"	1034188
S-4839F	62"	1034189

Wood Balusters



S-4040BT Starting Newel

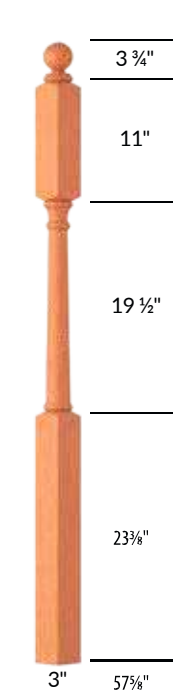

S-4045BT Landing Newel

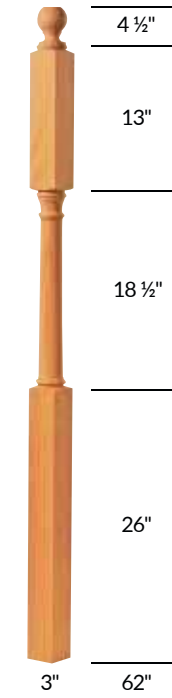

S-4046BT Landing Newel

MODEL #	(L)	SKU #
OAK		
S-4040BT	47-3/4"	1032846
S-4045BT	57-5/8"	1034053
S-4046BT	62"	1034057
HEMLOCK		
SW-H4045BT	57-5/8"	1039191



S-4240 Starting Newel

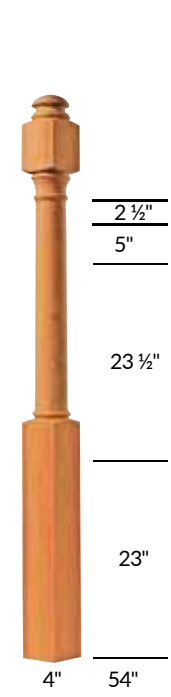

S-4242 Starting Newel

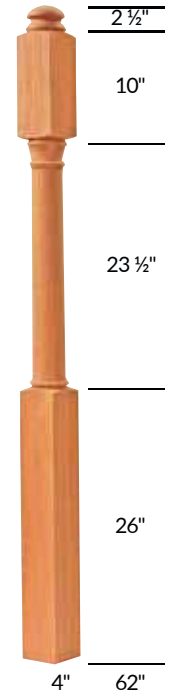

S-4245 Landing Newel

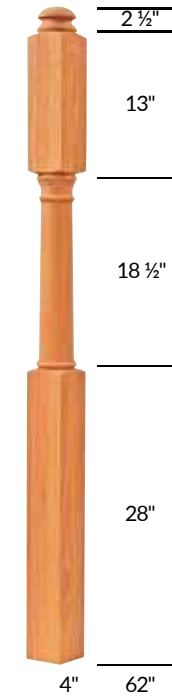

S-4246 Landing Newel

MODEL #	(L)	SKU #
OAK		
S-4240	48"	1034117
S-4242	54"	1034118
S-4245	62"	1034119
S-4246	62"	1034120

Wood Balusters

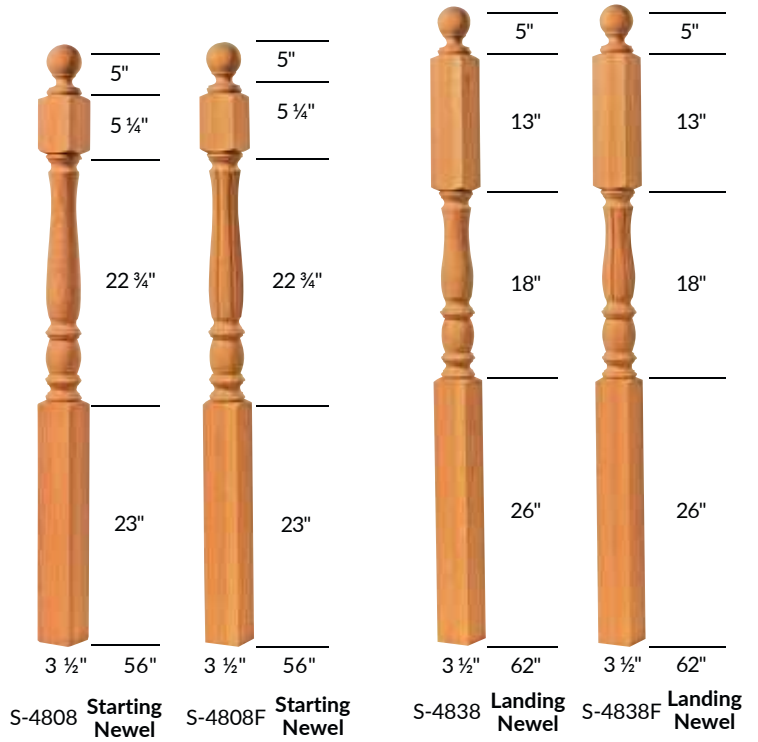
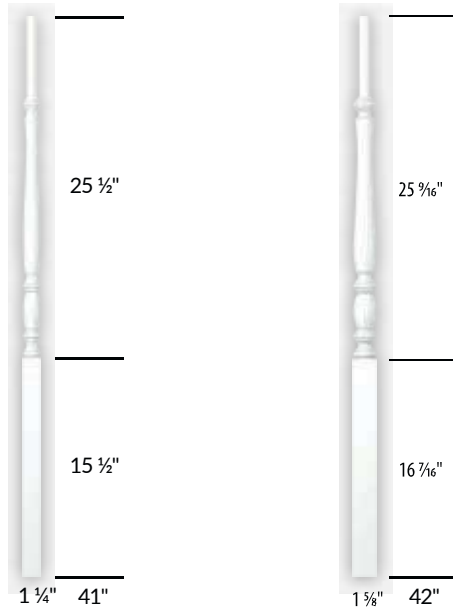

MODEL #	(L)	SKU #
PRIMED		
SW-PR5241-41	41"	1039459

MODEL #	(L)	SKU #
PRIMED		
SW-PR5341-42	42"	1039462

MODEL #	(L)	SKU #
OAK		
S-4808	56"	1034166
S-4808F	56"	1034172

MODEL #	(L)	SKU #
OAK		
S-4838	62"	1034183
S-4838F	62"	1034185

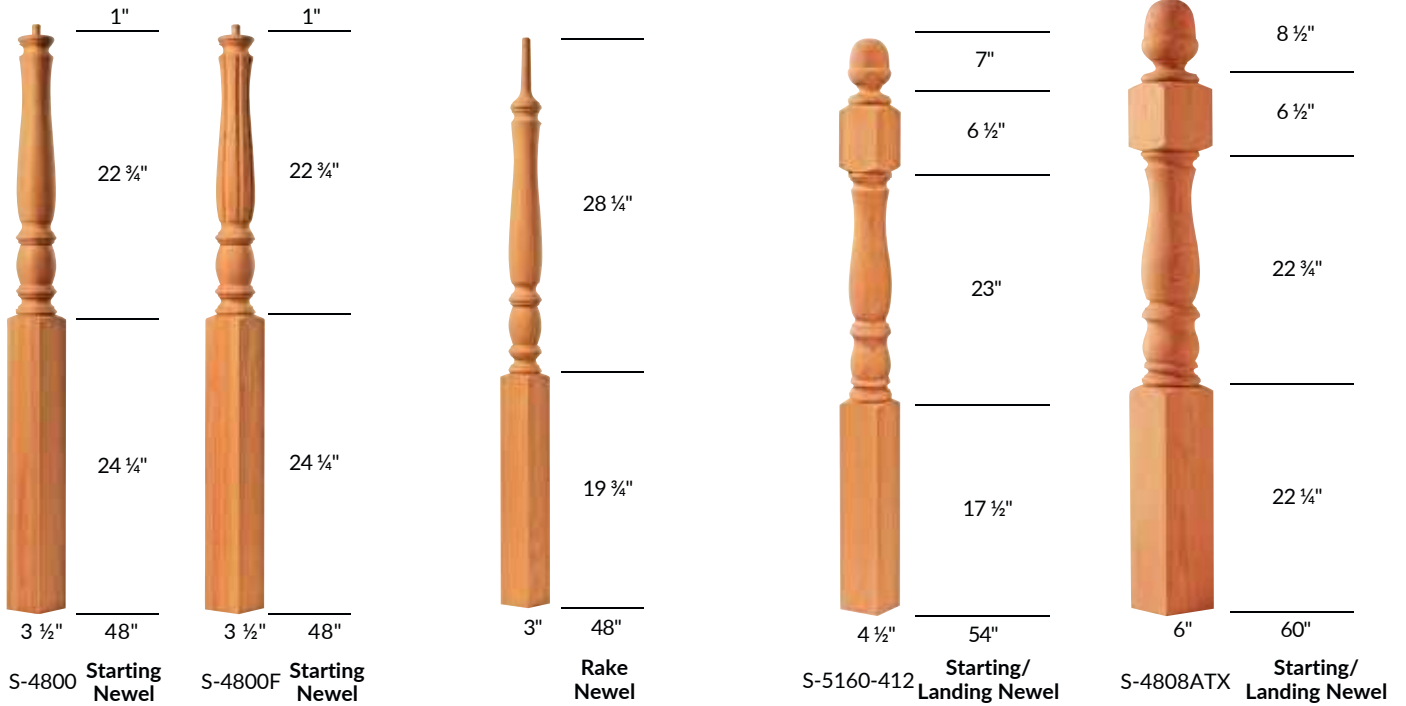

MODEL #	(L)	SKU #
OAK		
S-4800	48"	1034153
S-4800F	48"	1034156

MODEL #	(L)	SKU #
OAK		
S-4800RK	48"	1034157
HEMLOCK		
SW-H4800RK	48"	1039205

MODEL #	(L)	SKU #
OAK		
S-5160-412	54"	1032889
S-4808ATX	60"	1034171

Wood Balusters

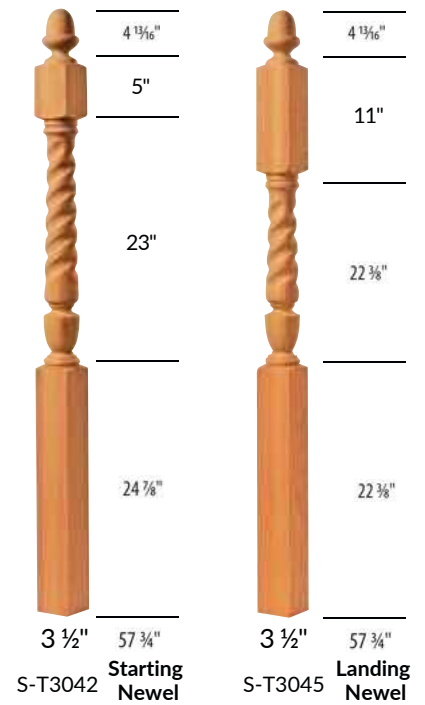
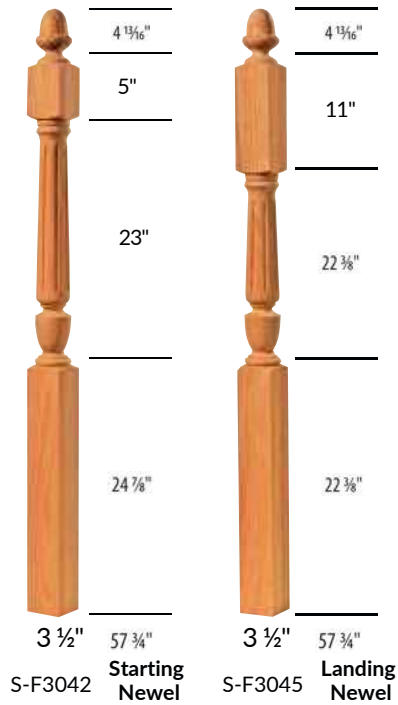
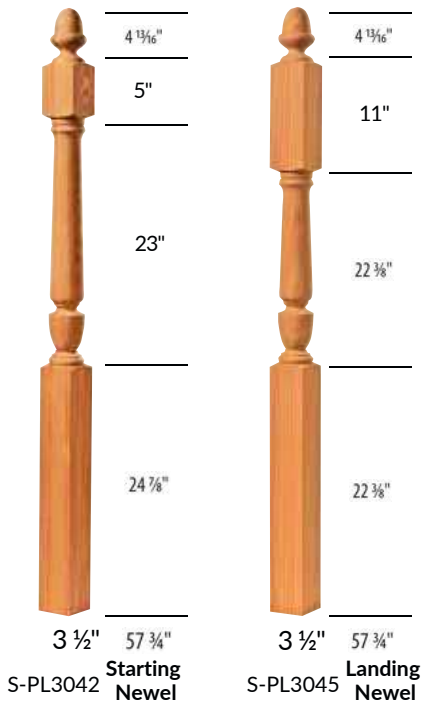

MODEL #	(L)	SKU #
OAK		
S-PL3042	57 3/4"	1037501
S-PL3045	57 3/4"	1037503

MODEL #	(L)	SKU #
OAK		
S-F3042	57 3/4"	1034832
S-F3045	57 3/4"	1034833

MODEL #	(L)	SKU #
OAK		
S-T3042	57 3/4"	1037810
S-T3045	57 3/4"	1037811

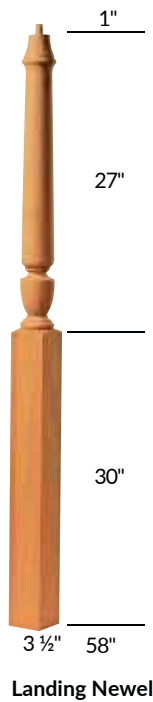

MODEL #	(L)	SKU #
OAK		
S-PL3015	58"	1037500

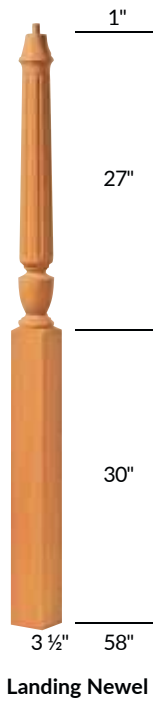

MODEL #	(L)	SKU #
OAK		
S-F3015	58"	1034831



MODEL #	(L)	SKU #
OAK		
S-T3015	58"	1037809

Wood Newels

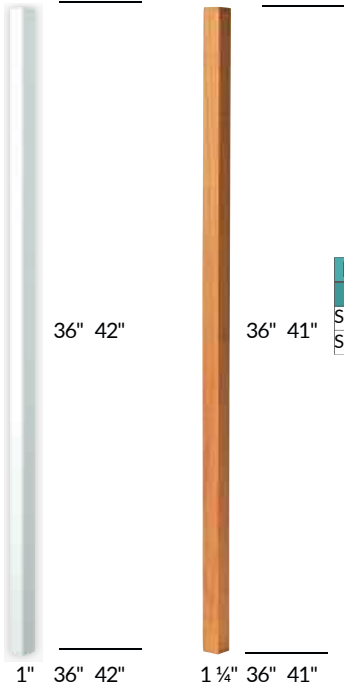

MODEL #	(L)	SKU #
PRIMED		
SW-PR5160-36	36"	1043578
SW-PR5160-42	42"	1043579

MODEL #	(L)	SKU #
OAK		
S-5060-36	36"	1032866
S-5060-41	41"	1032868
PRIMED		
SW-PR5060-36	36"	1039439
SW-PR5060-41	41"	1039440

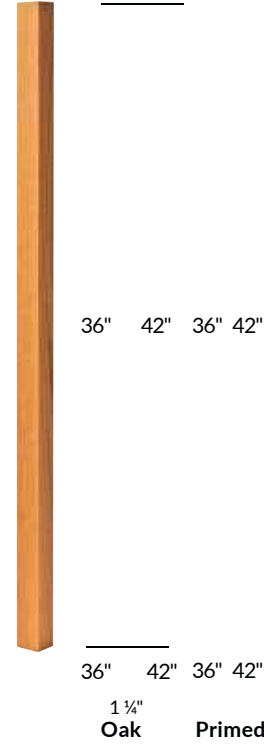

MODEL #	(L)	SKU #
OAK		
S-5360-36	36"	1032910
S-5360-42	42"	1032911
PRIMED		
SW-PR5360-36	36"	1039648
SW-PR5360-42	42"	1039649

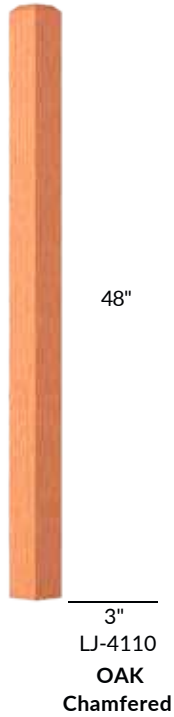

MODEL #	(L)	SKU #
OAK		
LJ-4110-O	48"	1043231

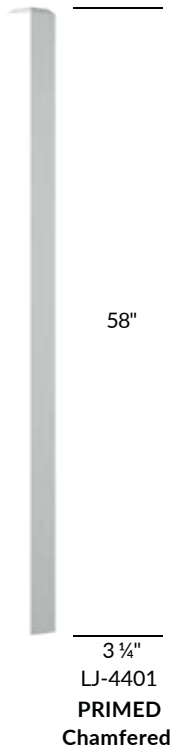

MODEL #	(L)	SKU #
PRIMED		
LJ-4401-PRG	58"	1043230



MODEL #	(L)	SKU #
OAK		
S-4000	56"	1032822
MAPLE		
S-M4000	56"	1043213
WHITE OAK		
S-WO4000	56"	1041479

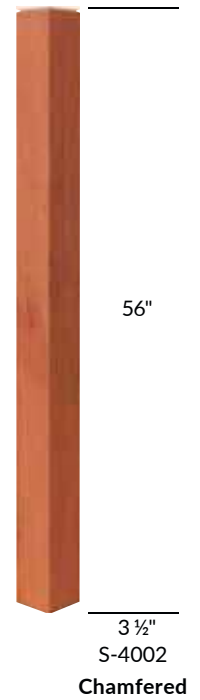

MODEL #	(L)	SKU #
OAK		
S-4002	56"	1032823

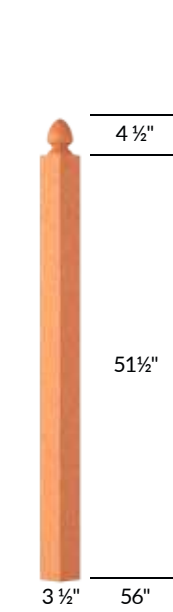

S-4005 Landing Newel

MODEL #	(L)	SKU #
OAK		
S-4005	56"	1032826

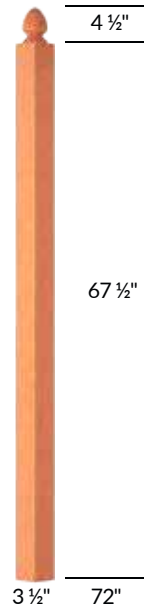

S-4006 Landing Newel

MODEL #	(L)	SKU #
OAK		
S-4006	72"	1032829



L J-4075-50 Box Newel

MODEL#	SPECIES	SKU#
3-1/2 WIDTH		
LJ-4075-50-O	OAK	1043214
LJ-4075-O	OAK	1043216
LJ-4175SL-O	OAK	1043218

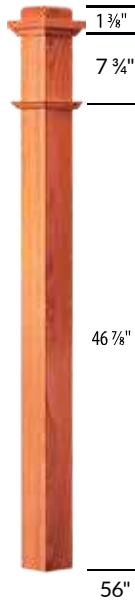

LJ-4075 Box Newel

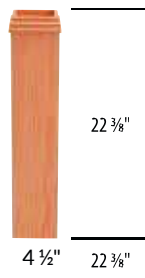

Sleeve for LJ-4175 Box Newel

MOEDEL #	SPECIES	SKU#
6-1/4 WIDTH		
LJ-4091-O	OAK	1043215

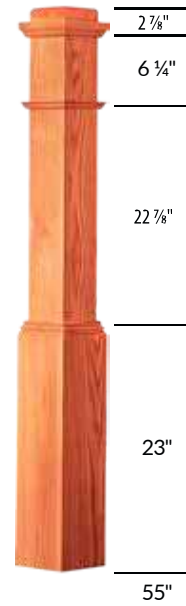

Box Newel

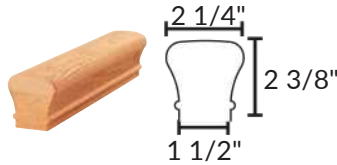

MODEL #	(L)	SKU #
FINGERJOINT		
OAK		
S-6010-6	6'	1042283
S-6010-8	8'	1032960
S-6010-10	10'	1032953
S-6010-12	12'	1032954
S-6010-14	14'	1032955
S-6010-16	16'	1032956
S-6010-20	20'	1032957
MAPLE		
S-M6010-8	8'	1042322
S-M6010-10	10'	1042323
S-M6010-12	12'	1036777
S-M6010-14	14'	1042324
S-M6010-16	16'	1042325
POPLAR		
SW-P6010-8	8'	1042244
SW-P6010-16	16'	1042248
WHITE OAK		
S-WO6010-8	8'	1043551
S-WO6010-12	12'	1043556
S-WO6010-16	16'	1043557
HEMLOCK		
SW-H6010-8	8'	1039261
SW-H6010-10	10'	1042384
SW-H6010-12	12'	1039258
SW-H6010-14	14'	1042385
SW-H6010-16	16'	1039260

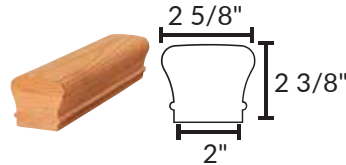

MODEL #	(L)	SKU #
OAK		
S-N6210-8	8'	1037132
S-N6210-10	10'	1037127
S-N6210-12	12'	1037128
S-N6210-14	14'	1042351
S-N6210-16	16'	1037130
S-N6210-20	20'	1037131
MAPLE		
S-M6210-16	16'	1035433
WHITE OAK		
S-WON6210-8	8'	1042352
S-WON6210-10	10'	1042353
S-WON6210-12	12'	1042354
S-WON6210-14	14'	1042355
S-WON6210-16	16'	1042356

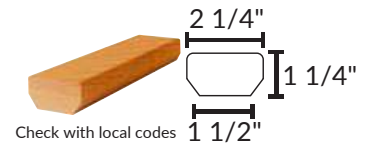

Check with local codes

MODEL #	(L)	SKU #
OAK		
S-6002-8	8'	1042268
S-6002-10	10'	1042269
S-6002-12	12'	1042270
S-6002-14	14'	1042271
S-6002-16	16'	1042272
HEMLOCK		
SW-H6002-8	8'	1042362
SW-H6002-10	10'	1042363
SW-H6002-12	12'	1042364
SW-H6002-16	16'	1042366
SW-H6002-18	18'	1042367

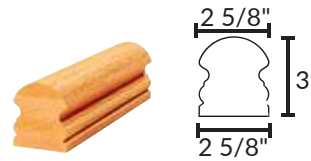

MODEL #	(L)	SKU #
OAK		
S-6019-16	16'	1042289

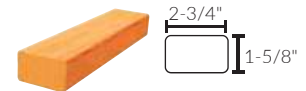

MODEL #	(L)	SKU #
OAK		
S-6000-8	8'	1042883
S-6000-10	10'	1042884
S-6000-12	12'	1042885
S-6000-14	14'	1042886
S-6000-16	16'	1042887
WHITE OAK		
S-WO6000-8	8'	1042888
S-WO6000-10	10'	1042889
S-WO6000-12	12'	1042890
S-WO6000-14	14'	1042891
S-WO6000-16	16'	1042892



Solid Cap Hand Rail

14' & 16' lengths may contain up to one visible butt joint on the cap

8', 10' & 12' lengths have a solid cap

Bottom two plays utilize finger joint construction

MODEL #	(L)	SKU #
OAK		
S-6010SC-8	8'	1032999
S-6010SC-10	10'	1032995
S-6010SC-12	12'	1032996
S-6010SC-14	14'	1042284
S-6010SC-16	16'	1032998

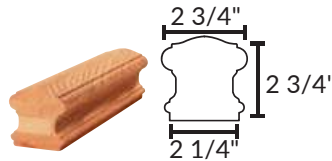

MODEL #	(L)	SKU #
OAK		
S-6710-8	8'	1042300
S-6710-10	10'	1042301
S-6710-12	12'	1034316
S-6710-14	14'	1042302
S-6710-16	16'	1034318
S-6710-20	20'	1034319

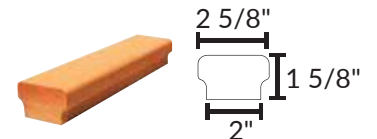

MODEL #	(L)	SKU #
OAK		
S-6003-8	8'	1042273
S-6003-10	10'	1042274
S-6003-12	12'	1042275
S-6003-14	14'	1042276
S-6003-16	16'	1042277
S-6003-20	20'	1042898
WHITE OAK		
S-WO6003-8	8'	1042346
S-WO6003-10	10'	1042347
S-WO6003-12	12'	1042348
S-WO6003-14	14'	1042349
S-WO6003-16	16'	1042350
S-WO6003-20	20'	1042899

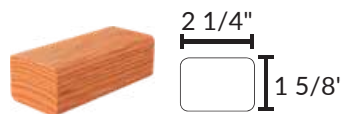

MODEL #	(L)	SKU #
OAK		
LJ-6102-16-O	16'	1043599



WARNING: Drilling, sawing, sanding or machining wood products can expose you to wood dust, a substance known to the State of California to cause cancer. Avoid inhaling wood dust or use a dust mask or other safeguards for personal protection. For more information go to www.P65Warnings.ca.gov/wood

Hand Rails

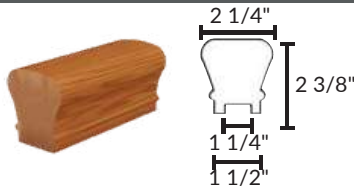

MODEL #	(L)	SKU #
FINGERJOINT		
OAK		
S-6010P-8	8'	1032993
S-6010P-10	10'	1042453
S-6010P-12	12'	1042454
S-6010P-16	16'	1032992
MAPLE		
S-M6010P-8	8'	1042491
S-M6010P-10	10'	1042492
S-M6010P-12	12'	1042493
S-M6010P-14	14'	1042494
S-M6010P-16	16'	1042495
HEMLOCK		
SW-H6010P-8	8'	1042443
SW-H6010P-10	10'	1042444
SW-H6010P-12	12'	1042445
SW-H6010P-14	14'	1042446
SW-H6010P-16	16'	1042447

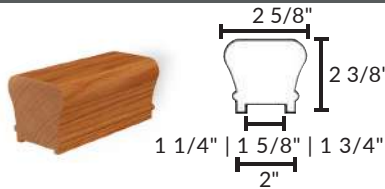

MODEL #	(L)	SKU #
OAK		
S-N6210P-8	8'	1042496
S-N6210P-10	10'	1042497
S-N6210P-12	12'	1042498
S-N6210P-14	14'	1042499
S-N6210P-16	16'	1042500
S-N6210P.4-8	8'	1042501
S-N6210P.4-10	10'	1042502
S-N6210P.4-12	12'	1042503
S-N6210P.4-14	14'	1042504
S-N6210P.4-16	16'	1042505
S-N6210P.8-8	8'	1042438
S-N6210P.8-10	10'	1042439
S-N6210P.8-12	12'	1042440
S-N6210P.8-14	14'	1042441
S-N6210P.8-16	16'	1042442
MAPLE		
S-M6210P-16	16'	1042475
S-M6210P.4-16	16'	1042480
S-M6210P.8-16	16'	1042437

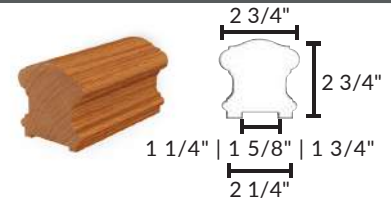

MODEL #	(L)	SKU #
OAK		
S-6710P-8	8'	1042536
S-6710P-10	10'	1042537
S-6710P-12	12'	1042538
S-6710P-14	14'	1042539
S-6710P-16	16'	1042540
S-6710P.4-8	8'	1042541
S-6710P.4-10	10'	1042542
S-6710P.4-12	12'	1042543
S-6710P.4-14	14'	1042544
S-6710P.4-16	16'	1042545
S-6710P.8-8	8'	1042531
S-6710P.8-10	10'	1042532
S-6710P.8-12	12'	1042533
S-6710P.8-14	14'	1042534
S-6710P.8-16	16'	1042535

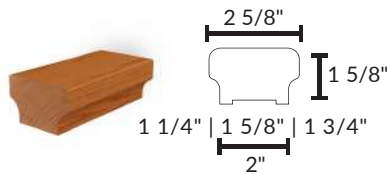

MODEL #	(L)	SKU #
OAK		
S-6003P-8	8'	1042576
S-6003P-10	10'	1042577
S-6003P-12	12'	1042578
S-6003P-14	14'	1042579
S-6003P-16	16'	1042580
S-6003P.4-8	8'	1042581
S-6003P.4-10	10'	1042582
S-6003P.4-12	12'	1042583
S-6003P.4-14	14'	1042584
S-6003P.4-16	16'	1042585
S-6003P.8-8	8'	1042586
S-6003P.8-10	10'	1042587
S-6003P.8-12	12'	1042588
S-6003P.8-14	14'	1042589
S-6003P.8-16	16'	1042590

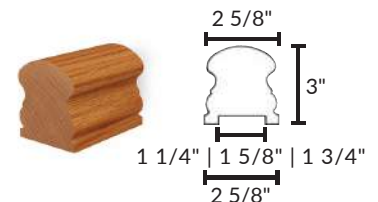

MODEL #	(L)	SKU #
OAK		
S-6019P-16	16'	1042460
S-6019P.4-16	16'	1042465
S-6019P.8-16	16'	1042470

Wood | Wall Rails

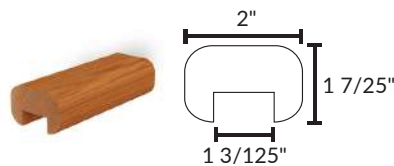

MODEL #	(L)	SKU #
PRIMED		
LI-6001P3-08-PRG	8'	1043225

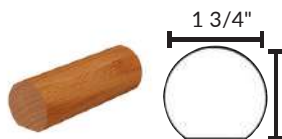

MODEL #	(L)	SKU #
OAK		
S-6040-8	8'	1034233
S-6040-10	10'	1034229
S-6040-12	12'	1034230
S-6040-14	14'	1042290
S-6040-16	16'	1034231
S-6040-20	20'	1034232
MAPLE		
S-M6040-8	8'	1042326
S-M6040-10	10'	1042327
S-M6040-12	12'	1042328
S-M6040-14	14'	1042329
S-M6040-16	16'	1042330
POPLAR		
SW-P6040-16	16'	1056347

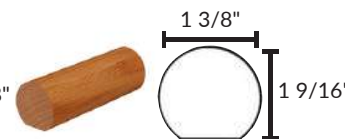

MODEL #	(L)	SKU #
HEMLOCK		
SW-H6040-8	8'	1039289
SW-H6040-10	10'	1042386
SW-H6040-12	12'	1039285
SW-H6040-14	14'	1042387
SW-H6040-16	16'	1039287
SW-H6040-20	20'	1039288

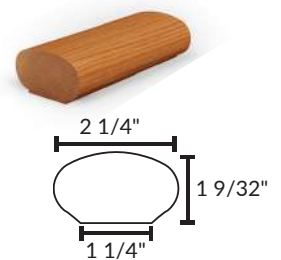

MODEL #	(L)	SKU #
OAK		
S-6042-8	8'	1042291
S-6042-12	12'	1042293
S-6042-16	16'	1042295
WHITE OAK		
S-WO6042-8	8'	1043560
S-WO6042-12	12'	1043561
S-WO6042-16	16'	1043562
HEMLOCK		
SW-H6042-16	16'	1039293

WARNING: Drilling, sawing, sanding or machining wood products can expose you to wood dust, a substance known to the State of California to cause cancer. Avoid inhaling wood dust or use a dust mask or other safeguards for personal protection. For more information go to www.P65Warnings.ca.gov/wood

Plowed Handrails

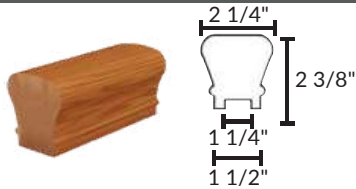

MODEL #	(L)	SKU #
FINGERJOINT		
OAK		
S-6010P-8	8'	1032993
S-6010P-10	10'	1042453
S-6010P-12	12'	1042454
S-6010P-16	16'	1032992
MAPLE		
S-M6010P-8	8'	1042491
S-M6010P-10	10'	1042492
S-M6010P-12	12'	1042493
S-M6010P-14	14'	1042494
S-M6010P-16	16'	1042495
HEMLOCK		
SW-H6010P-8	8'	1042443
SW-H6010P-10	10'	1042444
SW-H6010P-12	12'	1042445
SW-H6010P-14	14'	1042446
SW-H6010P-16	16'	1042447

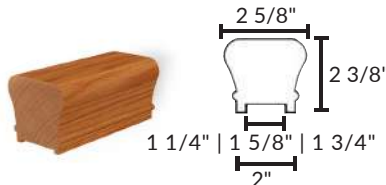

MODEL #	(L)	SKU #
OAK		
S-N6210P-8	8'	1042496
S-N6210P-10	10'	1042497
S-N6210P-12	12'	1042498
S-N6210P-14	14'	1042499
S-N6210P-16	16'	1042500
S-N6210P.4-8	8'	1042501
S-N6210P.4-10	10'	1042502
S-N6210P.4-12	12'	1042503
S-N6210P.4-14	14'	1042504
S-N6210P.4-16	16'	1042505
S-N6210P.8-8	8'	1042438
S-N6210P.8-10	10'	1042439
S-N6210P.8-12	12'	1042440
S-N6210P.8-14	14'	1042441
S-N6210P.8-16	16'	1042442
MAPLE		
S-M6210P-16	16'	1042475
S-M6210P.4-16	16'	1042480
S-M6210P.8-16	16'	1042437
WHITE OAK		
S-WON6210P-8	8'	1042566
S-WON6210P-10	10'	1042567
S-WON6210P-12	12'	1042568
S-WON6210P-14	14'	1042569
S-WON6210P-16	16'	1042570
S-WON6210P.4-8	8'	1042616
S-WON6210P.4-10	10'	1042617
S-WON6210P.4-12	12'	1042618
S-WON6210P.4-14	14'	1042619
S-WON6210P.4-16	16'	1042620
S-WON6210P.8-8	8'	1043582
S-WON6210P.8-10	10'	1043583
S-WON6210P.8-12	12'	1043584
S-WON6210P.8-14	14'	1043585
S-WON6210P.8-16	16'	1043586

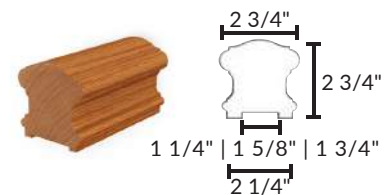

MODEL #	(L)	SKU #
OAK		
S-6710P-8	8'	1042536
S-6710P-10	10'	1042537
S-6710P-12	12'	1042538
S-6710P-14	14'	1042539
S-6710P-16	16'	1042540
S-6710P.4-8	8'	1042541
S-6710P.4-10	10'	1042542
S-6710P.4-12	12'	1042543
S-6710P.4-14	14'	1042544
S-6710P.4-16	16'	1042545
S-6710P.8-8	8'	1042531
S-6710P.8-10	10'	1042532
S-6710P.8-12	12'	1042533
S-6710P.8-14	14'	1042534
S-6710P.8-16	16'	1042535

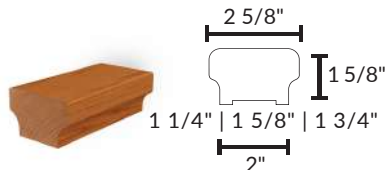

MODEL #	(L)	SKU #
OAK		
S-6003P-8	8'	1042576
S-6003P-10	10'	1042577
S-6003P-12	12'	1042578
S-6003P-14	14'	1042579
S-6003P-16	16'	1042580
S-6003P.4-8	8'	1042581
S-6003P.4-10	10'	1042582
S-6003P.4-12	12'	1042583
S-6003P.4-14	14'	1042584
S-6003P.4-16	16'	1042585
S-6003P.8-8	8'	1042586
S-6003P.8-10	10'	1042587
S-6003P.8-12	12'	1042588
S-6003P.8-14	14'	1042589
S-6003P.8-16	16'	1042590

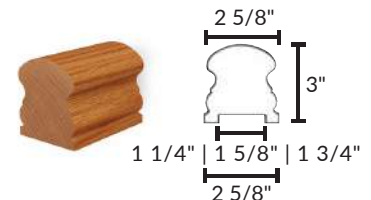

MODEL #	(L)	SKU #
OAK		
S-6019P-16	16'	1042460
S-6019P.4-16	16'	1042465
S-6019P.8-16	16'	1042470

Wood | Wall Rails

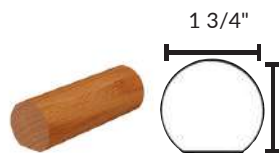

MODEL #	(L)	SKU #
OAK		
S-6040-8	8'	1034233
S-6040-10	10'	1034229
S-6040-12	12'	1034230
S-6040-14	14'	1042290
S-6040-16	16'	1034231
S-6040-20	20'	1034232
MAPLE		
S-M6040-8	8'	1042326
S-M6040-10	10'	1042327
S-M6040-12	12'	1042328
S-M6040-14	14'	1042329
S-M6040-16	16'	1042330
POPLAR		
SW-P6040-16	16'	1056347

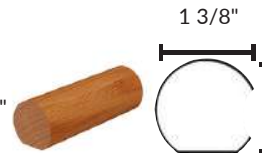

MODEL #	(L)	SKU #
HEMLOCK		
SW-H6040-8	8'	1039289
SW-H6040-10	10'	1042386
SW-H6040-12	12'	1039285
SW-H6040-14	14'	1042387
SW-H6040-16	16'	1039287
SW-H6040-20	20'	1039288

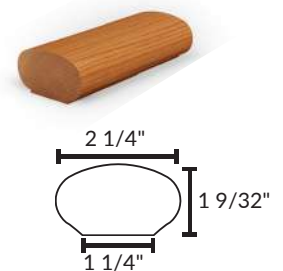

MODEL #	(L)	SKU #
OAK		
S-6042-8	8'	1042291
S-6042-12	12'	1042293
S-6042-16	16'	1042295
WHITE OAK		
S-WO6042-8	8'	1043560
S-WO6042-12	12'	1043561
S-WO6042-16	16'	1043562
HEMLOCK		
SW-H6042-16	16'	1039293



WARNING: Drilling, sawing, sanding or machining wood products can expose you to wood dust, a substance known to the State of California to cause cancer. Avoid inhaling wood dust or use a dust mask or other safeguards for personal protection. For more information go to www.P65Warnings.ca.gov/wood

Bending Handrails

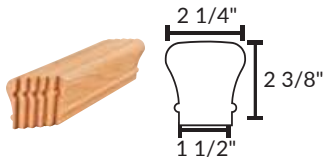

MODEL #	(L)	SKU #
OAK		
S-6010B-8	8'	1042403
S-6010B-12	12'	1042404
S-6010B-16	16'	1042405
S-6010B-20	20'	1032970
WHITE OAK		
S-WO6010B-8	8'	1043555
S-WO6010B-12	12'	1043558
S-WO6010B-16	16'	1043559

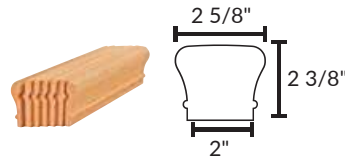

MODEL #	(L)	SKU #
OAK		
S-N6210B-8	8'	1042419
S-N6210B-12	12'	1042420
S-N6210B-16	16'	1042421
S-N6210B-20	20'	1037137
WHITE OAK		
S-WON6210B-8	8'	1042425
S-WON6210B-12	12'	1042426
S-WON6210B-16	16'	1042427

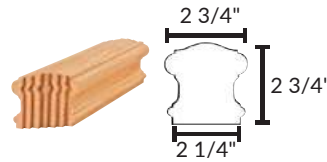

MODEL #	(L)	SKU #
OAK		
S-6710B-12	12'	1042408
S-6710B-16	16'	1042409
S-6710B-20	20'	1034322

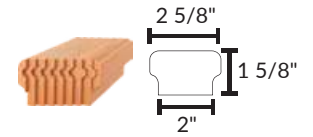

MODEL #	(L)	SKU #
OAK		
S-6003B-12	12'	1042900
S-6003B-16	16'	1042901
S-6003B-20	20'	1042902
WHITE OAK		
S-WO6003B-12	12'	1042903
S-WO6003B-16	16'	1042904
S-WO6003B-20	20'	1042905

Bending Mould

MODEL #	SKU #
S-6010BM	1032971
S-N6210BM	1037138
S-6710BM	1034324

Super Radial Bending Rail

MODEL #	(L)	SKU #
OAK		
S-6010BSP-8	8'	1032981
S-6010BSP-12	12'	1032977
S-6010BSP-16	16'	1032979
S-6010BSP-20	20'	1032980

MODEL #	(L)	SKU #
OAK		
S-N6210BSP-20	20'	1037140

MODEL #	(L)	SKU #
OAK		
S-6710BSP-20	20'	1034326

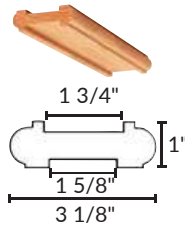

MODEL #	(L)	SKU #
OAK		
S-6006-8	8'	1042278
S-6006-10	10'	1042279
S-6006-12	12'	1042280
S-6006-14	14'	1042281
S-6006-16	16'	1042282

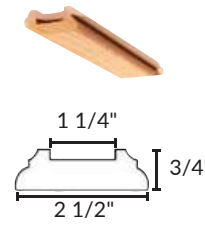

MODEL #	(L)	SKU #
OAK		
S-6045-8	8'	1034245
S-6045-10	10'	1042296
S-6045-12	12'	1042297
S-6045-14	14'	1042298
S-6045-16	16'	1042299

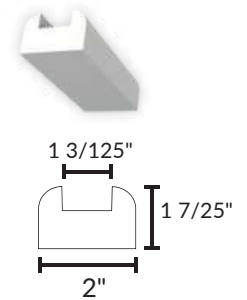

MODEL #	(L)	SKU #
PRIMED		
LJ-6001SP3-08-PRG	8'	1043227



MODEL #	SPECIES	SKU #
1" WIDTH		
LJ-6001FP3-03-PRG	PRIMED	1043224



MODEL #	SPECIES	SKU #
1-3/4" WIDTH		
OAK		
S-6007	OAK	1032946
MAPLE		
S-M6007	MAPLE	1036772
WHITE OAK		
S-WO6007	WHITE OAK	1038026

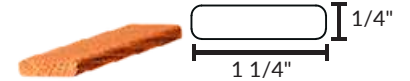

MODEL #	SPECIES	SKU #
1-1/4" WIDTH		
OAK		
LJ-6000F-O	OAK	1043223

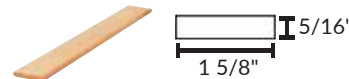

MODEL #	SPECIES	SKU #
1-5/8" WIDTH		
OAK		
S-6007A	OAK	1032948
MAPLE		
S-M6007A	MAPLE	1036773
WHITE OAK		
S-WO6007A	WHITE OAK	1038027

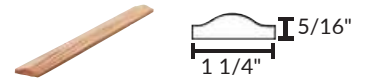

MODEL #	SPECIES	SKU #
1-1/4" WIDTH		
OAK		
S-6050	OAK	1034246
S-6050-3	OAK	1034249
MAPLE		
S-M6050	MAPLE	1035427
WHITE OAK		
S-WO6050	WHITE OAK	1038033
POPLAR		
SW-P6050	POPLAR	1042249

WARNING: Drilling, sawing, sanding or machining wood products can expose you to wood dust, a substance known to the State of California to cause cancer. Avoid inhaling wood dust or use a dust mask or other safeguards for personal protection. For more information go to www.P65Warnings.ca.gov/wood

Handrail Fittings



4" Return End

MODEL #	PROFILE	SKU #
OAK		
S-7009	6010HR	1033037
S-N7209	N6210HR	1038382
S-7709	6710HR	1035672



Starting Easing

MODEL #	PROFILE	SKU #
OAK		
S-7010	6010HR	1033038
S-N7210	N6210HR	1038383
S-7710	6710HR	1035673



Level Quarter Turn

MODEL #	PROFILE	SKU #
OAK		
S-7011	6010HR	1033039
S-N7211	N6210HR	1038384
S-7311	6003HR	1034427
S-7711	6710HR	1035675
WHITE OAK		
S-WO7011	6010HR	1043570
S-WO7311	6003HR	1040950



60° Up Easing

MODEL #	PROFILE	SKU #
OAK		
S-7012	6010HR	1033046
S-N7212	N6210HR	1038390
S-7712	6710HR	1035679
WHITE OAK		
S-WO7012	6010HR	1043571



Over Easing

MODEL #	PROFILE	SKU #
OAK		
S-7013	6010HR	1033048
S-N7213	N6210HR	1038392
S-7713	6710HR	1035682



90° Up Easing

MODEL #	PROFILE	SKU #
OAK		
S-7014	6010HR	1033051
S-N7214	N6210HR	1038394
S-7714	6710HR	1035685



Starting Easing Return End

MODEL #	PROFILE	SKU #
OAK		
S-7015	6010HR	1033052
S-N7215	N6210HR	1038395
S-7715	6710HR	1035686



Over Easing Return End

MODEL #	PROFILE	SKU #
OAK		
S-7016	6010HR	1033053
S-N7216	N6210HR	1038396
S-7716	6710HR	1035688



Opening Cap

MODEL #	PROFILE	SKU #
S-7019	6010HR	1033056
S-N7219	N6210HR	1038397
S-7719	6710HR	1035688



Tandem Cap

MODEL #	PROFILE	SKU #
OAK		
S-7020	6010HR	1033057
S-N7220	N6210HR	1038398
S-7320	6003HR	1035656
S-7720	6710HR	1035690
WHITE OAK		
S-WO7020	6010HR	1043573
S-WO7320	6003HR	1041084



90° Quarter Turn Cap

MODEL #	PROFILE	SKU #
OAK		
S-7021	6010HR	1033058
S-N7221	N6210HR	1038399
S-7321	6003HR	1035657
S-7721	6710HR	1035691
WHITE OAK		
S-WO7021	6010HR	1043572
S-WO7321	6003HR	1040894



135° Turn with Cap

MODEL #	PROFILE	SKU #
S-7021SP	6010HR	1033059
S-N7221SP	N6210HR	1038400
S-7721SP	6710HR	1035692



Oak
()



White Oak
(WO)

⚠ WARNING: Drilling, sawing, sanding or machining wood products can expose you to wood dust, a substance known to the State of California to cause cancer. Avoid inhaling wood dust or use a dust mask or other safeguards for personal protection. For more information go to www.P65Warnings.ca.gov/wood



Left Hand Volute

MODEL #	PROFILE	SKU #
OAK		
S-7030	6010HR	1033065
S-N7230	N6210HR	1038401
S-7730	6710HR	1035693
WHITE OAK		
S-WO7030	6010HR	1043563



Left Hand Volute Quick Rise

MODEL #	PROFILE	SKU #
OAK		
S-7033	6010HR	1033071
S-N7233	N6210HR	1038402
S-7733	6710HR	1035694



Right Hand Volute

MODEL #	PROFILE	SKU #
OAK		
S-7035	6010HR	1033072
S-N7235	N6210HR	1038403
S-7735	6710HR	1035695
WHITE OAK		
S-WO7035	6010HR	1043564



Right Hand Volute Quick Rise

MODEL #	PROFILE	SKU #
OAK		
S-7038	6010HR	1033083
S-N7238	N6210HR	1038404
S-7738	6710HR	1035696



5" Left Hand Turnout

MODEL #	PROFILE	SKU #
OAK		
S-7040	6010HR	1033084
S-N7240	N6210HR	1038405
S-7740	6710HR	1035697



3" Left Hand Turnout

MODEL #	PROFILE	SKU #
OAK		
S-7041	6010HR	1033085
S-N7241	N6210HR	1038406



5" Right Hand Turnout

MODEL #	PROFILE	SKU #
OAK		
S-7045	6010HR	1033086
S-N7245	N6210HR	1038407
S-7745	6710HR	1035699



3" Right Hand Turnout

MODEL #	PROFILE	SKU #
OAK		
S-7046	6010HR	1033087
S-N7246	N6210HR	1038408



Left Hand "S" Turn
(Use on Right side)

MODEL #	PROFILE	SKU #
OAK		
S-7047	6010HR	1033088
S-N7247	N6210HR	1038409
S-7747	6710HR	1035701



Right Hand "S" Turn
(Use on Left side)

MODEL #	PROFILE	SKU #
OAK		
S-7048	6010HR	1033090
S-N7248	N6210HR	1038410
S-7748	6710HR	1035702



Oak
(1)



White Oak
(WO)

WARNING: Drilling, sawing, sanding or machining wood products can expose you to wood dust, a substance known to the State of California to cause cancer. Avoid inhaling wood dust or use a dust mask or other safeguards for personal protection. For more information go to www.P65Warnings.ca.gov/wood

Handrail Fittings



Left Hand 2 Riser No Cap

MODEL #	PROFILE	SKU #
OAK		
S-7050	6010HR	1034347
S-N7250	N6210HR	1038411



Right Hand 2 Riser No Cap

MODEL #	PROFILE	SKU #
OAK		
S-7055	6010HR	1034348
S-N7255	N6210HR	1038412



Left Hand 2 Riser With Cap

MODEL #	PROFILE	SKU #
OAK		
S-7060	6010HR	1034349
S-N7260	N6210HR	1038413



Right Hand 2 Riser With Cap

MODEL #	PROFILE	SKU #
OAK		
S-7065	6010HR	1034350
S-N7265	N6210HR	1038414
S-7765	6710HR	1035707



Left Hand 2 Riser No Cap

MODEL #	PROFILE	SKU #
OAK		
S-7071	6010HR	1034352
S-N7271	N6210HR	1038416
S-7771	6710HR	1035708



Right Hand 2 Riser No Cap

MODEL #	PROFILE	SKU #
OAK		
S-7076	6010HR	1034354
S-N7276	N6210HR	1038418
S-7776	6710HR	1035709



Left Hand 2 Riser With Cap

MODEL #	PROFILE	SKU #
OAK		
S-7081	6010HR	1034356
S-N7281	N6210HR	1038420
S-7781	6710HR	1035710
WHITE OAK		
S-WO7081	6010HR	1043566



Right Hand 2 Riser With Cap

MODEL #	PROFILE	SKU #
OAK		
S-7086	6010HR	1034358
S-N7286	N6210HR	1038422
S-7786	6710HR	1035711
WHITE OAK		
S-WO7086	6010HR	1043567



2 Riser with Tandem Cap

MODEL #	PROFILE	SKU #
OAK		
S-7088-2	6010HR	1034360
S-N7288-2	N6210HR	1038424
S-7788-2	6710HR	1035713
WHITE OAK		
S-WO7088-2	6010HR	1043568



2 Riser with Cap

MODEL #	PROFILE	SKU #
OAK		
S-7097	6010HR	1034364
S-N7297	N6210HR	1038428



2 Riser No Cap

MODEL #	PROFILE	SKU #
OAK		
S-7099	6010HR	1034367
S-N7299	N6210HR	1038430
S-7799	6710HR	1035715
WHITE OAK		
S-WO7099	6010HR	1043569



Quarter Turn

MODEL #	PROFILE	SKU #
OAK		
S-7023	S-6040	1033060



Starting Easing

MODEL #	PROFILE	SKU #
OAK		
S-7024	S-6040	1033061



Over Easing

MODEL #	PROFILE	SKU #
OAK		
S-7025	S-6040	1033062



Oak
()



White Oak
(WO)

WARNING: Drilling, sawing, sanding or machining wood products can expose you to wood dust, a substance known to the State of California to cause cancer. Avoid inhaling wood dust or use a dust mask or other safeguards for personal protection. For more information go to www.P65Warnings.ca.gov/wood



MODEL #	SPECIES	SKU #
Pyramid Cap for both 4091 & 4075 Newels		
S-4091PTOP	OAK	1034083
S-WO4091PTOP	WHITE OAK	1038022
Pyramid Cap for 6 1/4" Box Newels		
S-4091XLPTOP	OAK	1034094
Pyramid Cap for 7 1/2" Box Newels		
S-4091XXLPTOP	OAK	1034102
SW-P4091XXLPTOP	POPLAR	1039338



MODEL #	SPECIES	SKU #
Flat Cap for both 4091 & 4075 Newels		
S-4091FTOP	OAK	1034078
S-WO4091FTOP	WHITE OAK	1038021
Flat Cap for 6 1/4" Box Newels		
S-4091XLFTOP	OAK	1034092
SW-P4091XLFTOP	POPLAR	1039330
Flat Cap for 7 1/2" Box Newels		
S-4091XXLFTOP	OAK	1034100

Round Rosette



MODEL #	(SIZE)	SKU #
OAK		
S-7017	4-1/2"	1033054
S-7217	5"	1034383
WHITE OAK		
S-WO7017	4-1/2"	1043565

Oval Rosette



MODEL #	(SIZE)	SKU #
OAK		
S-7037	4" X 5-1/2" 6-	1033079
S-7037C	1/2" X 4-7/16"	1033081
S-7237	5-1/2" X 6"	1034393
MAPLE		
S-M7037	4" X 5-1/2"	1036820
WHITE OAK		
S-WO7037	4" X 5-1/2"	1042895

Rectangle Rosette



MODEL #	(SIZE)	SKU #
OAK		
S-7036	4-5/16" X 6"	1033078
MAPLE		
J-7033-M	4-5/16" X 6"	4700100
WHITE OAK		
J-7033-WO	4-5/16" X 6"	4700108



Wall Rail Brackets



Wall Rail Bracket Wall to Centerline: 2 3/4"
Hardware included.

MODEL #	FINISH	SKU #
S-3002B	BLACK	1032784
S-3002	BRASS	1032783
S-3002C	CHROME	1032785
S-3002SN	S. NICKEL	1032794

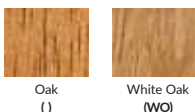

Wall Rail Bracket - Heavy Duty
Wall to Centerline: 2 3/4"

MODEL #	FINISH	SKU #
S-3002H	BRASS	1032786
S-3002HSN	S. NICKEL	1032792
S-3002HORB	BRONZE	1032790
S-3002HC	CHROME	1032788
S-3002HB	BLACK	1032787

WARNING: Drilling, sawing, sanding or machining wood products can expose you to wood dust, a substance known to the State of California to cause cancer. Avoid inhaling wood dust or use a dust mask or other safeguards for personal protection. For more information go to www.P65Warnings.ca.gov/wood

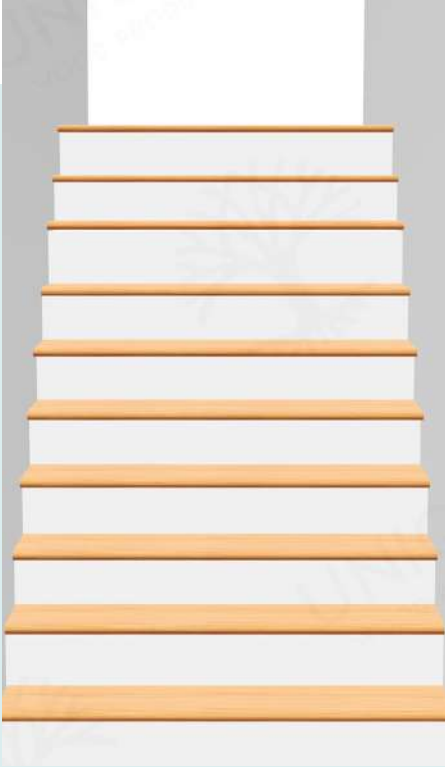

Wall to wall stair treads



8070 STAIR TREADS 1" THICK

- RED OAK - STOCKED FROM 36" TO 96"
- FABRICATED TO ORDER: RED OAK, WHITE OAK, HICKORY AND MAPLE
- CUSTOM | OTHER SPECIES AVAILABLE

8070-42

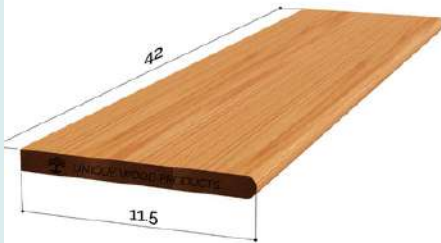

Outside dimensions - 42" x 11.5" x 1.03125"
[Tread thickness has working tolerance of +/- .03125"]

8070-48

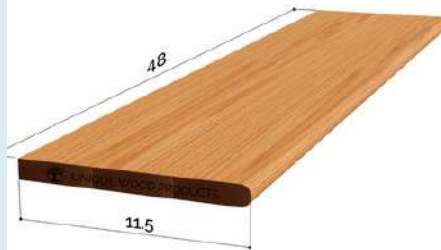

Outside dimensions - 48" x 11.5" x 1.03125"
[Tread thickness has working tolerance of +/- .03125"]

8070-60

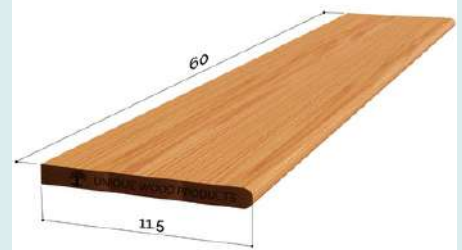

Outside dimensions - 60" x 11.5" x 1.03125"
[Tread thickness has working tolerance of +/- .03125"]

8070-72

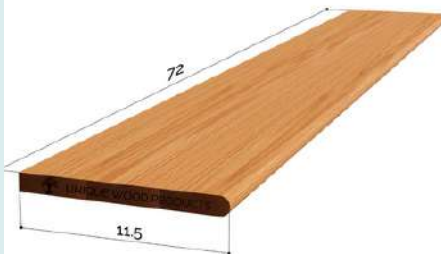

Outside dimensions - 72" x 11.5" x 1.03125"
[Tread thickness has working tolerance of +/- .03125"]

8070-84

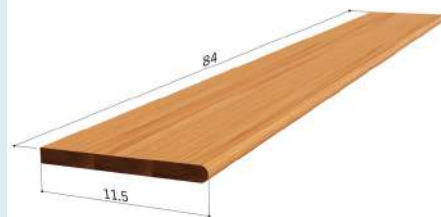

Outside dimensions - 84" x 11.5" x 1.03125"
[Tread thickness has working tolerance of +/- .03125"]

8070-96

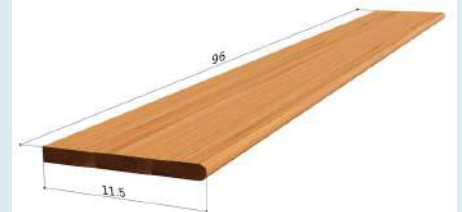

Outside dimensions - 96" x 11.5" x 1.03125"
[Tread thickness has working tolerance of +/- .03125"]

8070 MITERED RETURN STAIR TREADS

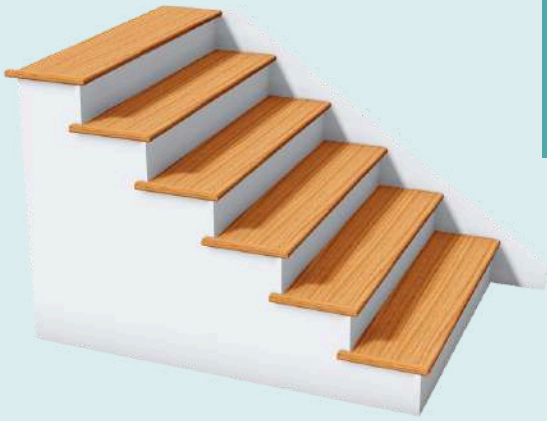

MITERED RETURN 1" TREADS (LH SHOWN)

- USE WITH OPEN STAIRCASE
- RED OAK - STOCKED IN 48", 54" & 60"
- FABRICATED TO ORDER: RED OAK, WHITE OAK, HICKORY AND MAPLE
- CUSTOM | OTHER SPECIES AVAILABLE



8070-48MR

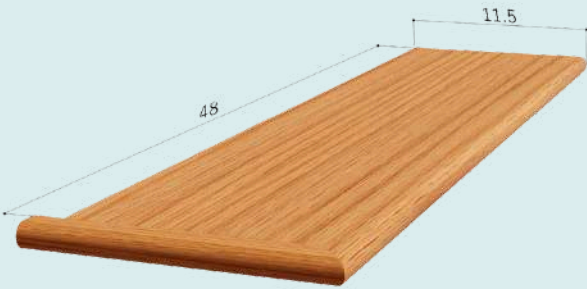

Outside dimensions - 96" x 11.5" x 1.03125"

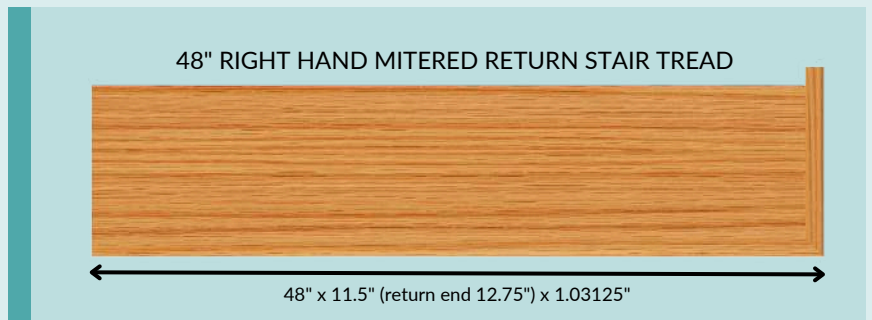
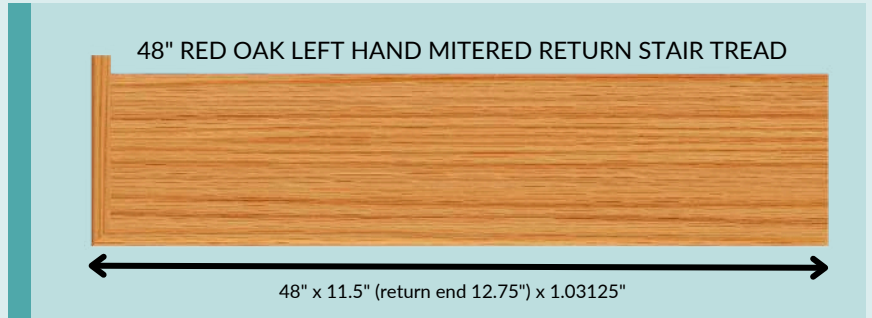

8070-60MR

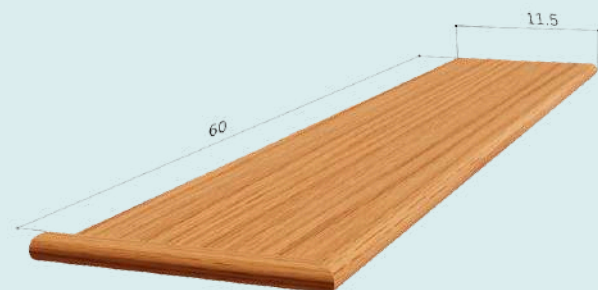

Outside dimensions - 96" x 11.5" x 1.03125"



8071 RETRO-FIT STAIR TREADS

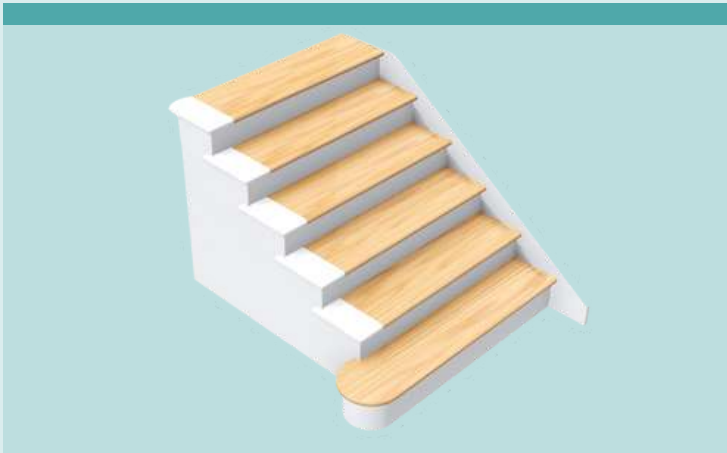

- RENOVATION & REMODELING TREADS RED OAK - STOCK 42" & 48"
- ALL OTHER SIZES: CUSTOM
- RED OAK, WHITE OAK
- HICKORY & MAPLE
- OTHER SPECIES AVAILABLE

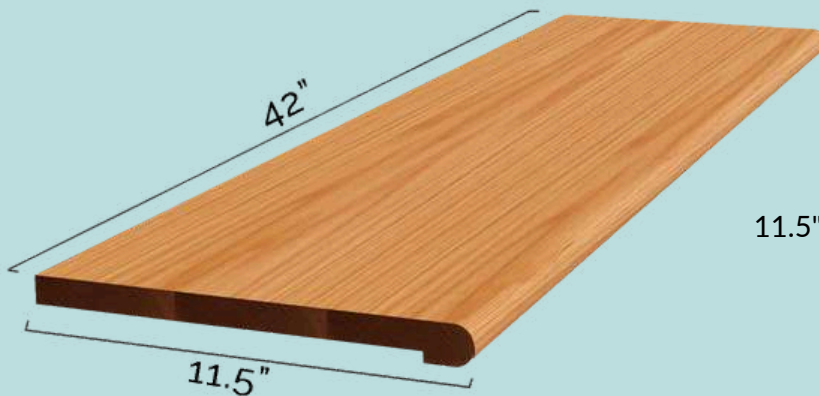

8071-42MR

11.5" x 42" x 0.625" with 1" BN



8071-48MR

11.5" x 48" x 0.625" with 1" BN

LANDING TREADS

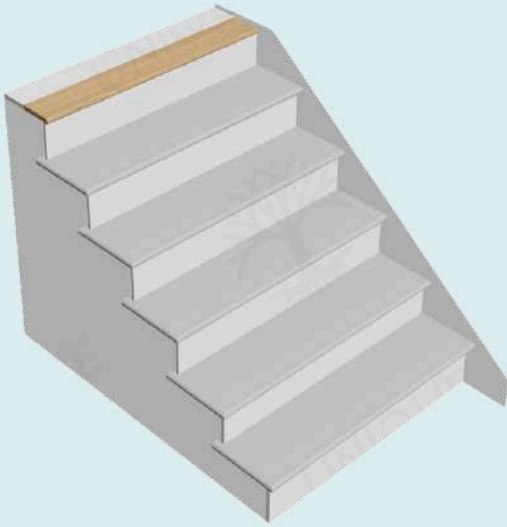

- RED OAK
- WHITE OAK
- HICKORY
- MAPLE
- CUSTOM

8091 LANDING TREAD

5.25" X 1.03125" X RANDOM LENGTHS

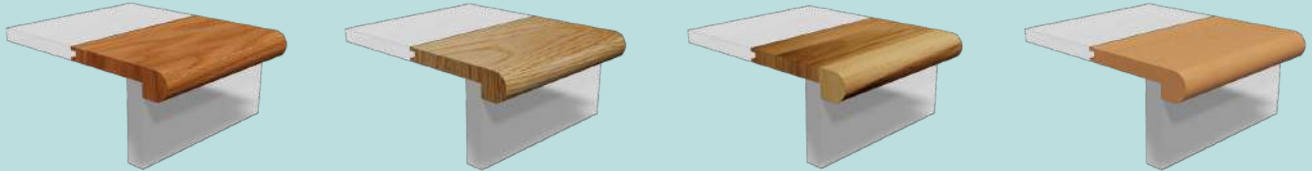

8090 LANDING TREAD

3.25" X 1.03125" X RANDOM LENGTHS



8070 PLATFORM LANDINGS



- RED OAK - STOCK
48" X 48" X 1"
- RED OAK
- WHITE OAK
- HICKORY
- MAPLE
- CUSTOM

807048

RED OAK PLATFORM LANDINGS

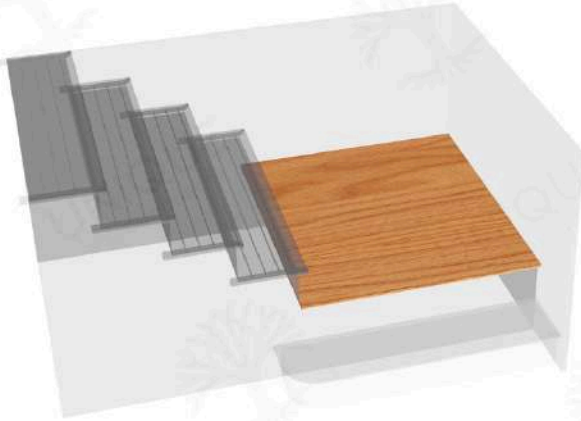

807048

WHITE OAK PLATFORM LANDINGS

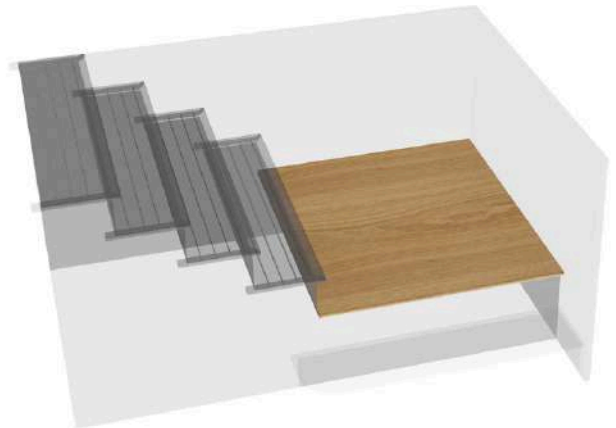

807048

HICKORY PLATFORM LANDINGS

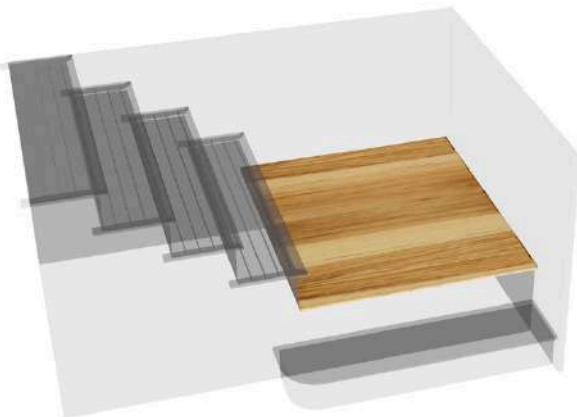

807048

MAPLE PLATFORM LANDINGS

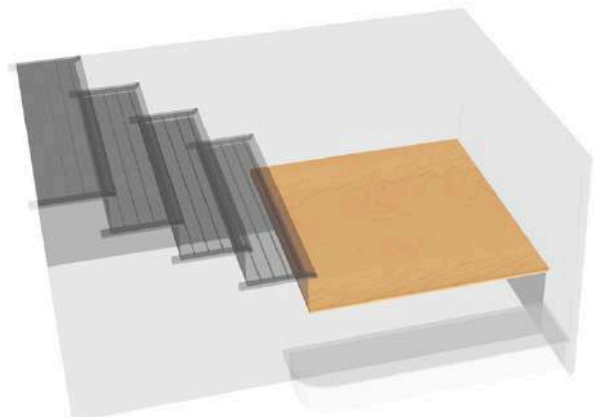

CURVED STAIRCASE



- RED OAK
- WHITE OAK
- HICKORY
- MAPLE
- CUSTOM

8005RH CUSTOM
RIGHT HAND PIE SHAPED TREADS
CUSTOM

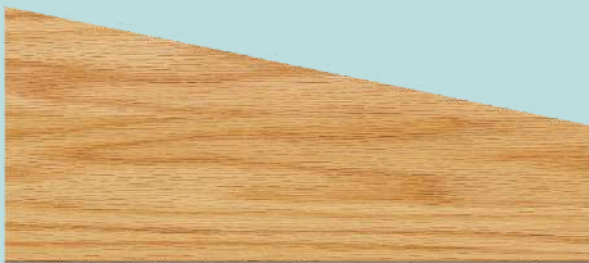

8005LH CUSTOM
LEFT HAND PIE SHAPED TREADS
CUSTOM

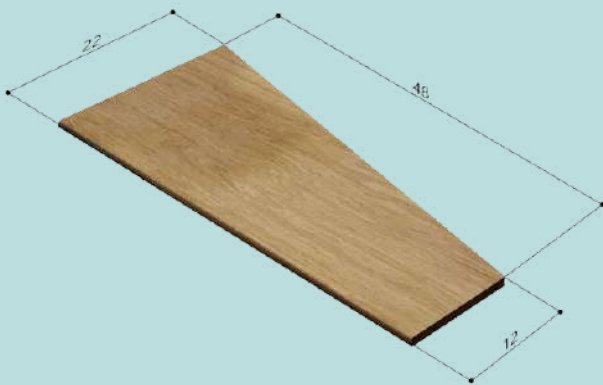
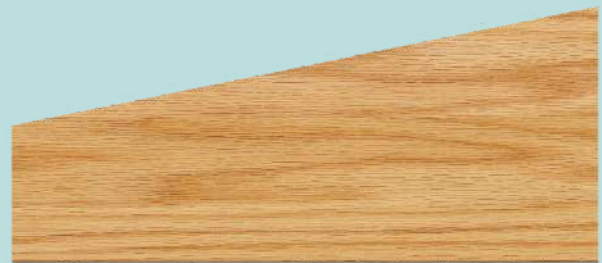

Curved Staircases have Pie Shaped Treads, each tread will probably have similar dimensions, Please provide the dimension for each stair tread so that we can manufacture it accordingly. Please provide as much support as you can with the stair treads such as staircase images and any dimensions that are required to fabricate the stair treads. Please allow two to six weeks for completion as custom templates are "made to order".

8075 RISERS



- PRIMED PINE 8075
90" X 7.5" X 1/2"
- RED OAK, WHITE OAK, MAPLE
3/4" X 7.5" X RL (RANDOM LENGTHS)

STAIR RISER

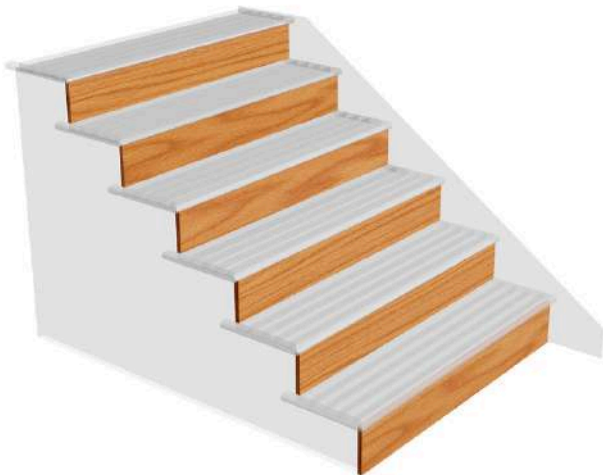

8075

WHITE OAK TREADS AND RISERS



8075

RED OAK TREAD PRIMED RISERS

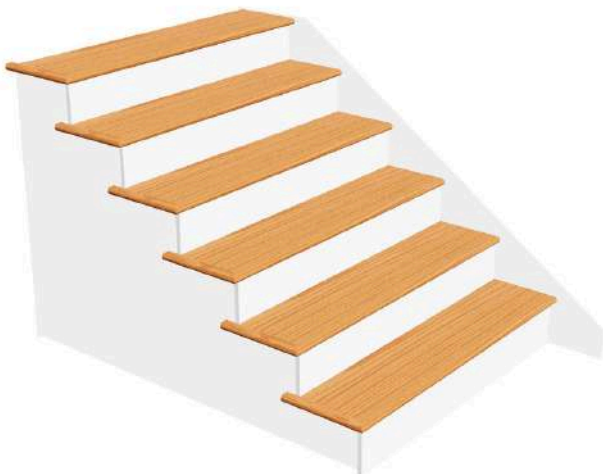

807048

HICKORY TREADS AND RISERS



- 48", 54", 60" & 72"
- CUSTOM - RED OAK, WHITE OAK, HICKORY & MAPLE
- CUSTOM | OTHER SPECIES AVAILABLE

8010 SINGLE BULLNOSED STARTING STEP



RED OAK 8070 (MR),
8010 STARTING STEP AND PRIMED RISERS



WHITE OAK 8070MR TREADS,
8010 STARTING STEP & WHITE OAK RISERS



HICKORY 8070MR TREADS,
8010 STARTING STEP & HICKORY RISERS

8010-48LH LEFT SIDE ROUNDED END



Outside dimensions - 58.375" x 17.75" x 1.03125"

8010-48RH RIGHT SIDE ROUNDED END



Outside dimensions - 58.375" x 17.75" x 1.03125"

8010-54LH

LEFT SIDE ROUNDED END

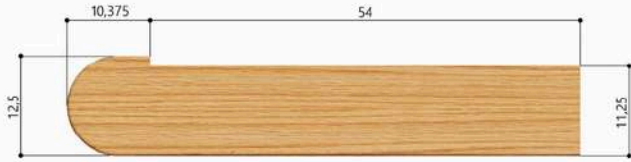

Outside dimensions - 64.375" x 17.75" x 1.03125"

8010-54RH

RIGHT SIDE ROUNDED END

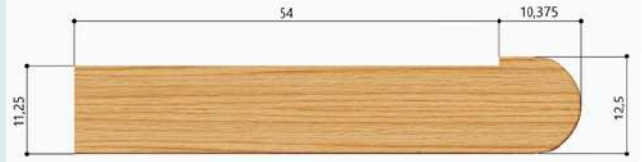

Outside dimensions - 64.375" x 17.75" x 1.03125"

8010-60LH

LEFT SIDE ROUNDED END



Outside dimensions - 70.375" x 17.75" x 1.03125"

8010-60RH

RIGHT SIDE ROUNDED END

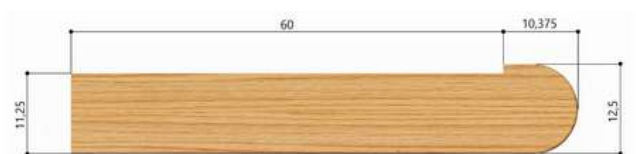

Outside dimensions - 70.375" x 17.75" x 1.03125"

8010-72LH

LEFT SIDE ROUNDED END



Outside dimensions - 82.375" x 17.75" x 1.03125"

8010-72RH

RIGHT SIDE ROUNDED END



Outside dimensions - 82.375" x 17.75" x 1.03125"



8015-48

DOUBLE SIDED ROUNDED END



Outside dimensions - 68.75" x 12.5" x 1.0325"

8015 DOUBLE ROUNDED END STARTING STEP

- 48", 54" & 60"
- RED OAK, WHITE OAK
- HICKORY & MAPLE
- CUSTOM | OTHER SPECIES AVAILABLE

8015-54

DOUBLE SIDED ROUNDED END

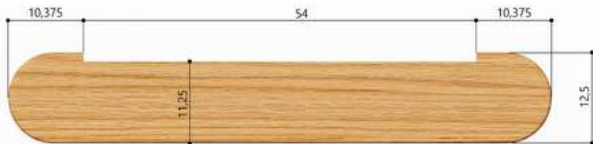

Outside dimensions - 74.75" x 12.5" x 1.0325"

8015-60

DOUBLE SIDED ROUNDED END



Outside dimensions - 80.75" x 12.5" x 1.0325"

8030 HALF CIRCLE STARTING STEP

- 48" AND 60"
- RED OAK, WHITE OAK
- HICKORY & MAPLE
- CUSTOM | OTHER SPECIES AVAILABLE

8030 RED OAK TREADS AND WHITE RISERS

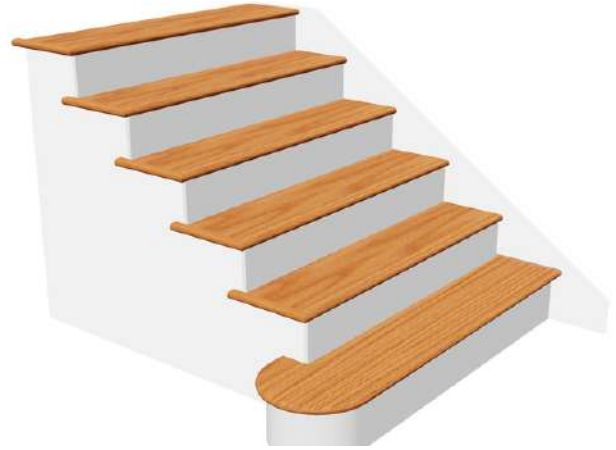

8030-48LH

LEFT SIDE HALF CIRCLE END
USE WITH NEWEL

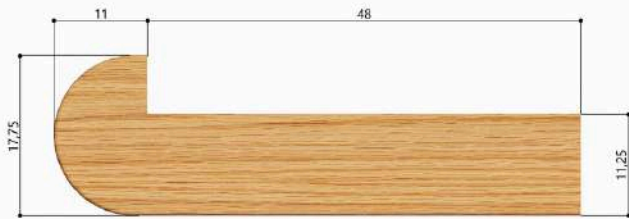

Outside dimensions - 59" x 17.75" x 1.03125"

8030-48RH

RIGHT SIDE HALF CIRCLE END
USE WITH NEWEL

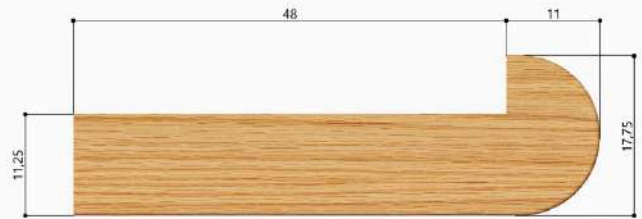

Outside dimensions - 59" x 17.75" x 1.03125"

8030-60LH

LEFT SIDE HALF CIRCLE END
USE WITH NEWEL

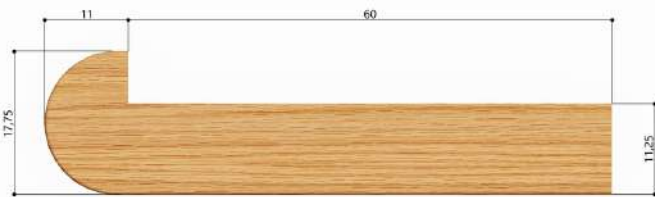

Outside dimensions - 71" x 17.75" x 1.03125"

8030-60RH

RIGHT SIDE HALF CIRCLE END
USE WITH NEWEL

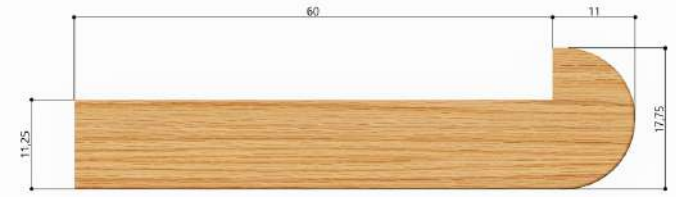

Outside dimensions - 71" x 17.75" x 1.03125"

8040 QUARTER CIRCLE STARTING STEP



- 48" AND 60"
- CUSTOM
- RED OAK, WHITE OAK
- HICKORY & MAPLE
- OTHER SPECIES AVAILABLE

8040 RED OAK TREAD

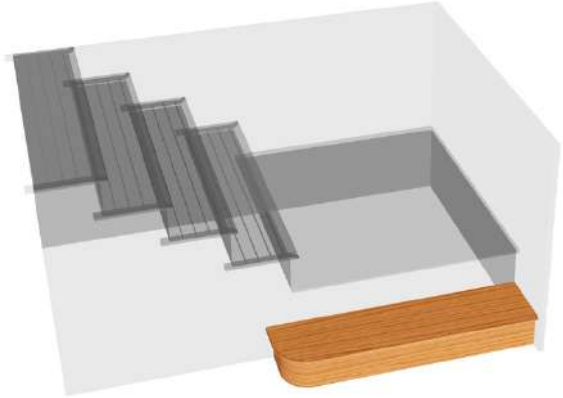

8040-48LH QUARTER CIRCLE END



Outside dimensions - 48" x 11.5" x 1.03125"

8030-48RH QUARTER CIRCLE END

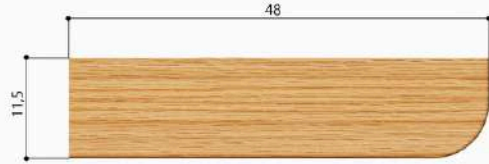

Outside dimensions - 48" x 11.5" x 1.03125"

8040-60LH QUARTER CIRCLE END

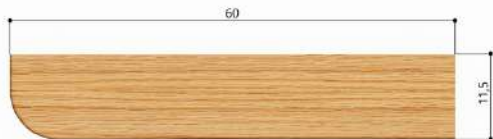

Outside dimensions - 60" x 11.5" x 1.03125"

8040-60RH QUARTER CIRCLE END



Outside dimensions - 60" x 11.5" x 1.03125"

- 48", 60" & 72"
- CUSTOM
- RED OAK, WHITE OAK
- HICKORY & MAPLE
- OTHER SPECIES AVAILABLE

8060 DOUBLE QUARTER CIRCLE STARTING STEP

8060 HICKORY OAK TREAD

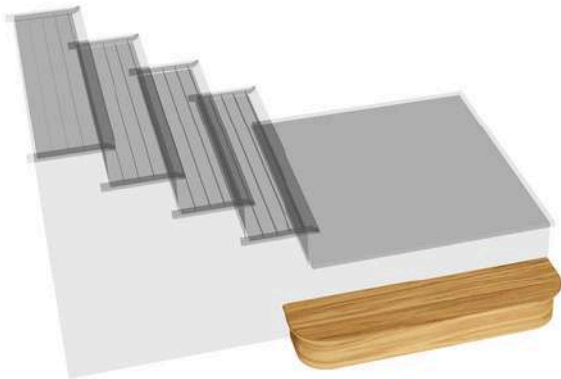

8060 WHITE OAK TREAD

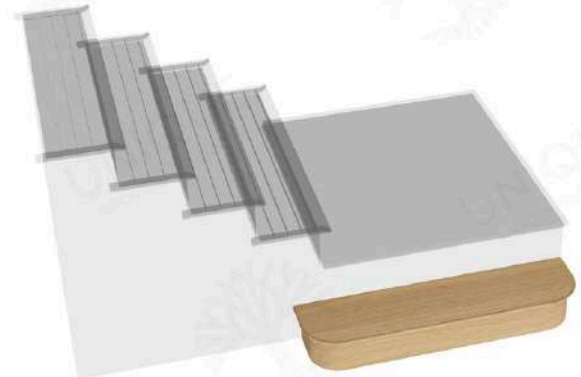

8060-48

DOUBLE QUARTER CIRCLE



Outside dimensions - 48" x 11.5" x 1.03125"

8060-60

DOUBLE QUARTER CIRCLE



Outside dimensions - 60" x 11.5" x 1.03125"

8021 THREE STEP WINDER STAIR TREADS

- RED OAK
- MAPLE
- WHITE OAK
- CUSTOM
- HICKORY

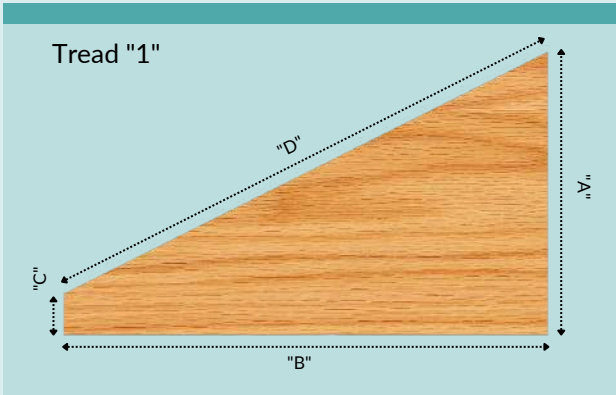

DIMENSION "A" _____

DIMENSION "B" _____

DIMENSION "C" _____

DIMENSION "D" _____

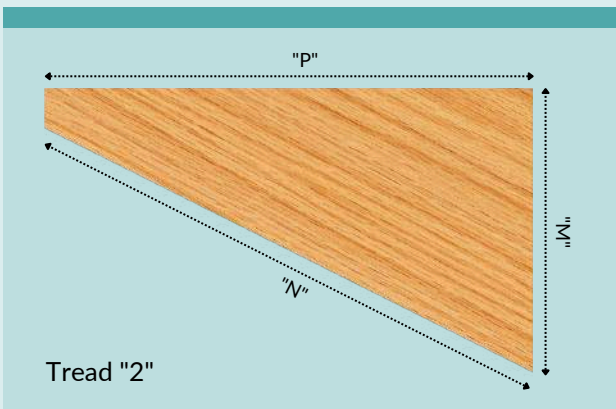

DIMENSION "M" _____

DIMENSION "N" _____

DIMENSION "O" _____

DIMENSION "P" _____

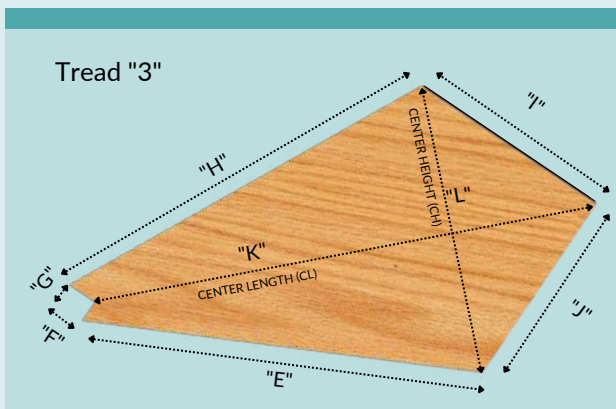

DIMENSION "E" _____

DIMENSION "F" _____

DIMENSION "G" _____

DIMENSION "H" _____

A paper template (minimum poster paper or cardboard thickness) of the stair tread with the carpet off, is required as not all staircase are squared and perfect. Please provide as much support as you can with the stair treads such as staircase images and any dimensions that are required to fabricate the stair treads. Please allow two to six weeks for completion as custom templates are "made to order".

8022 TWO STEP WINDER STAIR TREADS

- RED OAK
- MAPLE
- WHITE OAK
- CUSTOM
- HICKORY

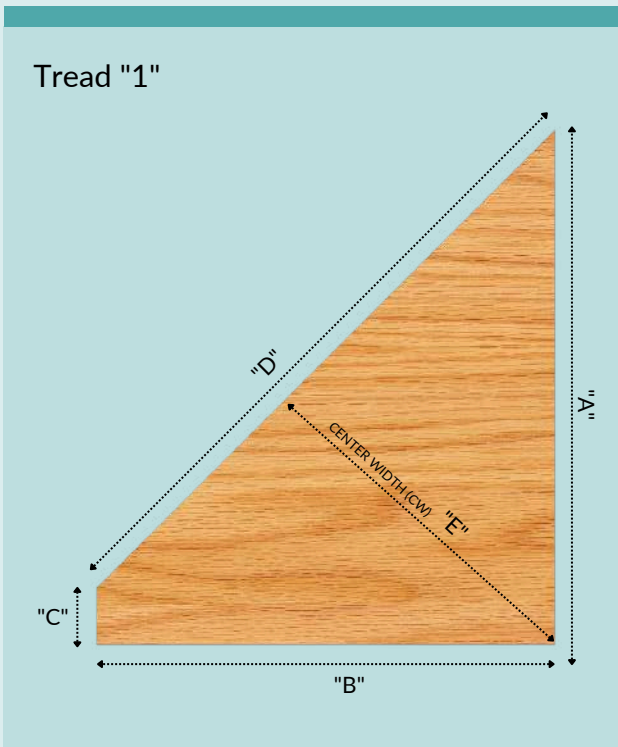

DIMENSION "A" _____

DIMENSION "B" _____

DIMENSION "C" _____

DIMENSION "D" _____

DIMENSION "E" _____

A paper template (minimum poster paper or cardboard thickness) of the stair tread with the carpet off, is required as not all staircase are squared and perfect. Please provide as much support as you can with the stair treads such as staircase images and any dimensions that are required to fabricate the stair treads. Please allow two to six weeks for completion as custom templates are "made to order".

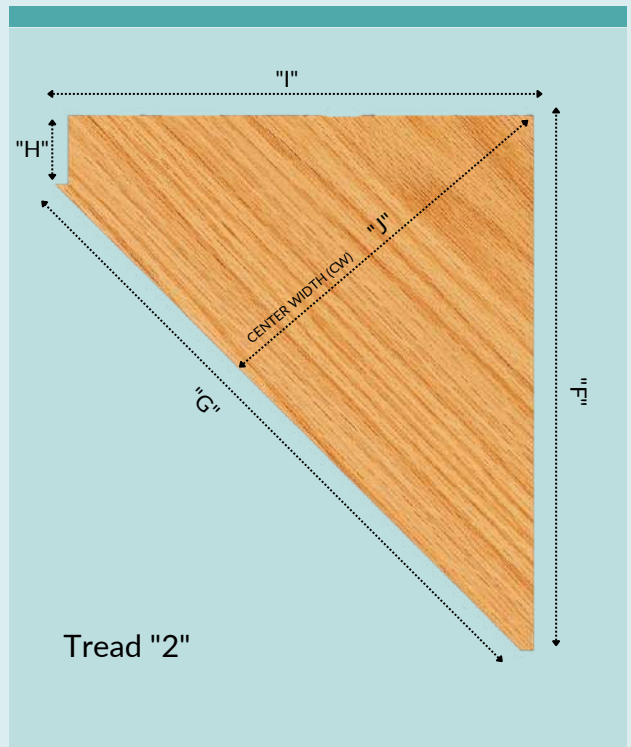

DIMENSION "F" _____

DIMENSION "G" _____

DIMENSION "H" _____

DIMENSION "I" _____

DIMENSION "J" _____

8023 TWO STEP SQUARE EDGED STARTING TREADS



- RED OAK
- WHITE OAK
- HICKORY
- MAPLE
- CUSTOM

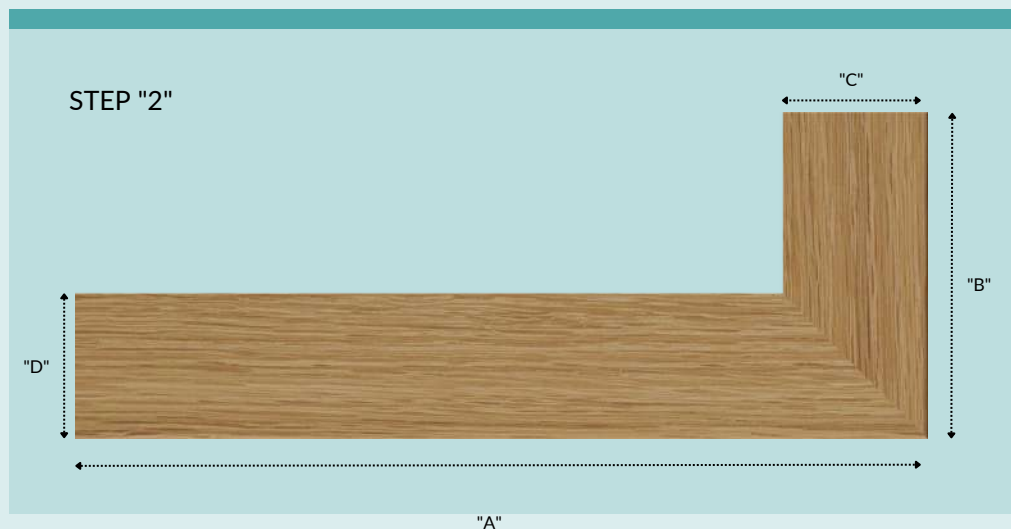
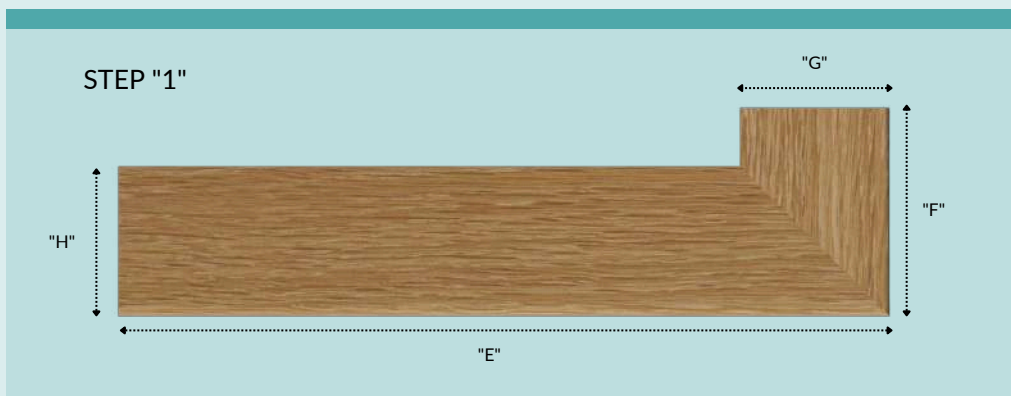

Template and measurements needed

DIMENSION "A" _____

DIMENSION "B" _____

DIMENSION "C" _____

DIMENSION "D" _____

DIMENSION "E" _____

DIMENSION "F" _____

DIMENSION "H" _____

A paper template (minimum poster paper or cardboard thickness) of the stair tread with the carpet off, is required as not all staircase are squared and perfect. Please provide as much support as you can with the stair treads such as staircase images and any dimensions that are required to fabricate the stair treads. Please allow two to six weeks for completion as custom templates are "made to order".

THREE STEP CURVED STARTING TREADS

(up to 55" first step)



- RED OAK
- WHITE OAK
- HICKORY
- MAPLE
- CUSTOM

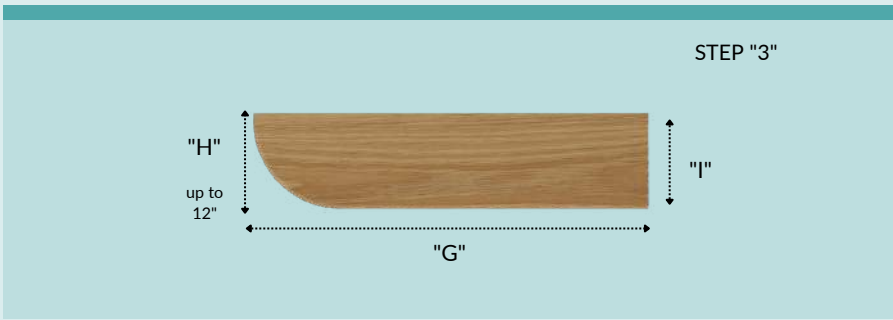

DIMENSION "A" _____

DIMENSION "B" _____

DIMENSION "C" _____

DIMENSION "D" _____

DIMENSION "E" _____

DIMENSION "F" _____

DIMENSION "G" _____

DIMENSION "H" _____

DIMENSION "I" _____

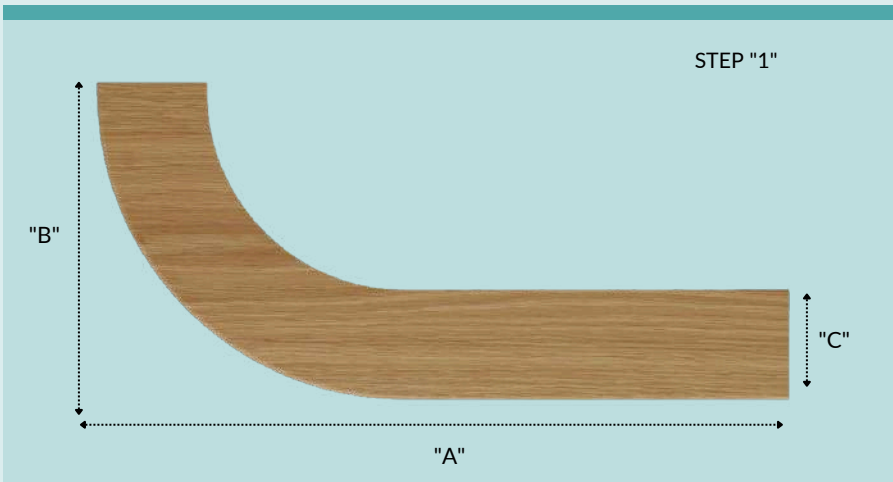
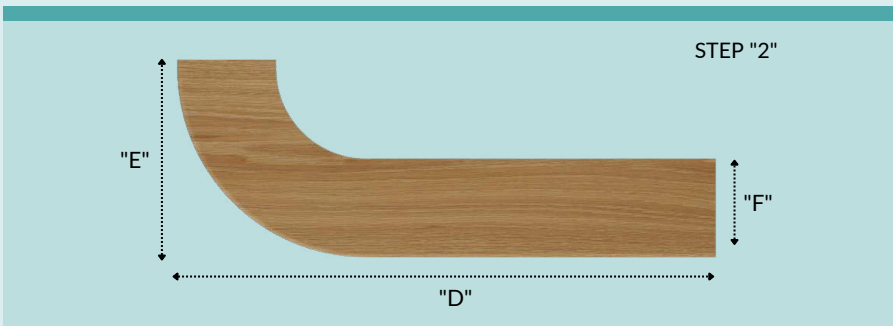

A paper template (minimum poster paper or cardboard thickness) of the stair tread with the carpet off, is required as not all staircase are squared and perfect. Please provide as much support as you can with the stair treads such as staircase images and any dimensions that are required to fabricate the stair treads. Please allow two to six weeks for completion as custom templates are "made to order".

TWO STEP CURVED STARTING TREADS

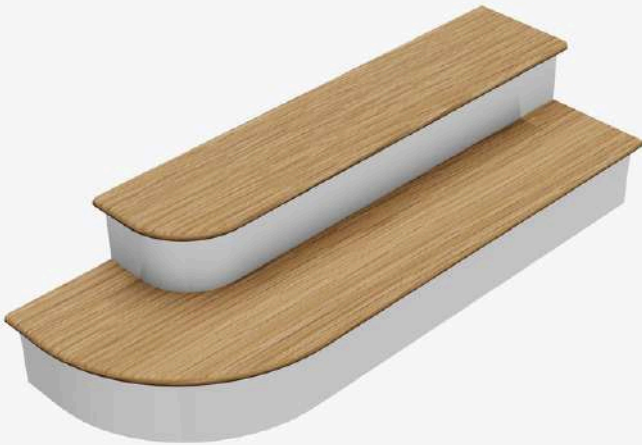

- RED OAK
- WHITE OAK
- HICKORY
- MAPLE
- CUSTOM

STEP "1"

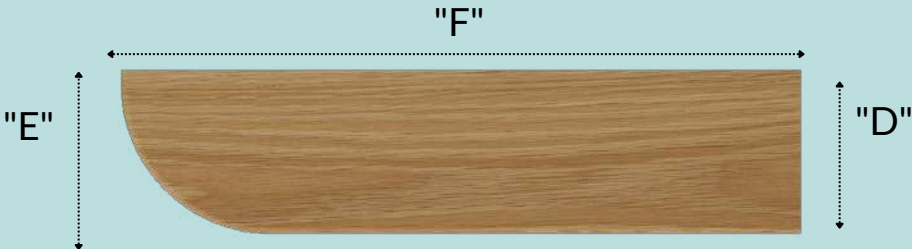

STEP "2"

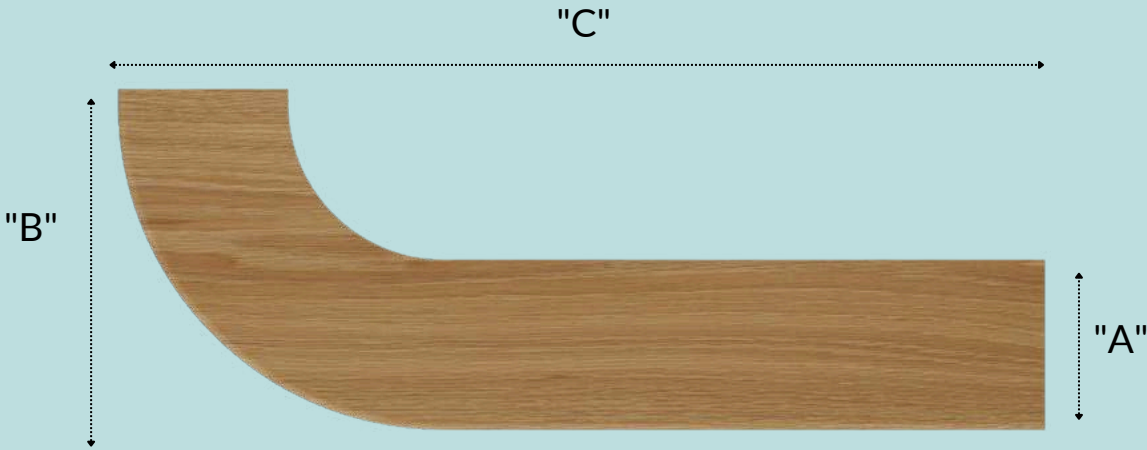

DIMENSION "A" _____
 DIMENSION "B" _____
 DIMENSION "C" _____

DIMENSION "D" _____
 DIMENSION "E" _____
 DIMENSION "F" _____

A paper template (minimum poster paper or cardboard thickness) of the stair tread with the carpet off, is required as not all staircase are squared and perfect. Please provide as much support as you can with the stair treads such as staircase images and any dimensions that are required to fabricate the stair treads. Please allow two to six weeks for completion as custom templates are "made to order".

CUSTOM OR STOCK STAIR PARTS

- WINDER TREADS, PIE SHAPED OR CURVED STAIRCASE ARE OUR SPECIALTY
- SOURCE LUMBER AVAILABLE TO MANUFACTURE YOUR STAIRCASE PROJECT
- ABILITY TO IN-HOUSE MANUFACTURE STAIR TREADS UP TO 16' LONG AND A THICKNESS UP TO 4"
- FABRICATE CURVED STAIR TREAD OR LANDING

The best way to get an accurate stair part is images, and/or templates or an accurate scaled-drawing with photographs. Send us dimensions along with the quantity and wood species needed for a quote.

WE OFFER CUSTOM STAIR PARTS FOR COMMERCIAL, RESIDENTIAL AND PANELING PROJECTS. WE CAN MATCH EXISTING ARCHITECTURAL PATTERN FOR FIRE/WATER DAMAGE REPLACEMENT, ADDITIONS AND REMODEL.

RED OAK

POPLAR

ASH

WHITE OAK

WALNUT

ALDER

MAPLE

PINE

BEECH

CHERRY

MAHOGANY

HICKORY

Custom In-House Wood Products

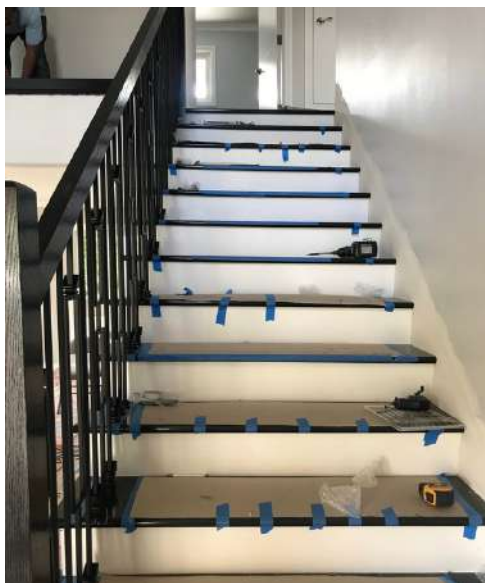

Custom In-House Wood Products



THICK TREADS



HICKORY TREADS



CUSTOM XXL LANDINGS



CUSTOM STARTING



WO SQ RTN ENDS



CUSTOM HANDRAILS



CUSTOM



CURVED TREADS



CURVED OPEN TREADS

Custom In-House Wood Products



TEMPLATED TREADS



THICK RO TREADS



WO RIFT & QUARTERED



LANDING TEMPLATE



DOUBLE MITERED



WO STARTING



CUSTOM TEMPLATE



WO BOXED TREADS



CURVED TEMPLATES

Millwork Facility



BUSINESS TERMS:

Not all drawings are to size. The dimensions listed are as correct, actual size and shape of products may vary due to manufacturing and are subject to change without notice. . Follow all manufactures guidelines and recommendations as well as the highest and best building practices, respectively, for intended use.

CLAIMS:

Any product that falls below industry standards will be exchanged or replaced at no additional cost to purchaser. All defective claims must be made prior to installation of products. Seller accepts no responsibility for labor, or other loss, experienced by the buyer because of use of the seller's products.

SHORTAGES:

All shortages must also be made prior to installation of products. Inspection of products before installation is the responsibility of the customer.

CUSTOM MILLWORK:

Solid hardwood or softwood millworks and mouldings are manufactured in random lengths unless quoted to project specification. As lumber is a product of nature, variation in texture, color of grain patterns are natural & to be expected. Due to the natural growth differences in species, some are limited in lengths of boards available. Many hardwoods are usually 9'-12' lengths but come as short as 6' or as long as 16' dependent upon lumber availability. Random lengths orders may include a maximum of 15% short lengths from 3' to 6' and 85% in lengths from 7' to 16'. Specific Length orders are subject to lumber availability and subject to a 25% upcharge in price.

CUSTOM/SPECIAL ORDER:

A minimum of 50% deposit is required on all custom or special order products, no exceptions. All special order or custom order millwork are non-refundable or returnable once the order has been started in production. Some special order products may be returned or exchanged subject to a 25% restocking fee. All returns or exchanges must be returned in original package, no cut, dirty, painted, or wet material will be returned, any material returned for reasons other than quality will be subject to a 25% restocking charge.

STORAGE, HANDLING AND PREPARATION OF ALL MILLWORK:

Wood is hygroscopic, expanding as relative humidity levels increase and contracting when it loses moisture. Professionals refer to the relationship between wood and humidity as "equilibrium moisture content" (EMC). As the relative humidity in the environment increases, so does the moisture content in wood and the EMC so keep all wood away from the direct sunlight and water.

Being based in Houston, Unique Wood products and our clientele are somewhat familiar with moisture and the damage it can do to lumber, again we strictly recommend all millwork must be effectively and continuously protected from exposure to direct sunlight, ground contact and other similar elements. To prevent changes in EMC, millwork should be stored only in a dry, clean location and fully protected from water and high moisture. All millwork products must be "acclimated" to the environment by storing in the installation space for at least 3 days prior to installation to prevent bowing, splitting or gap formation.

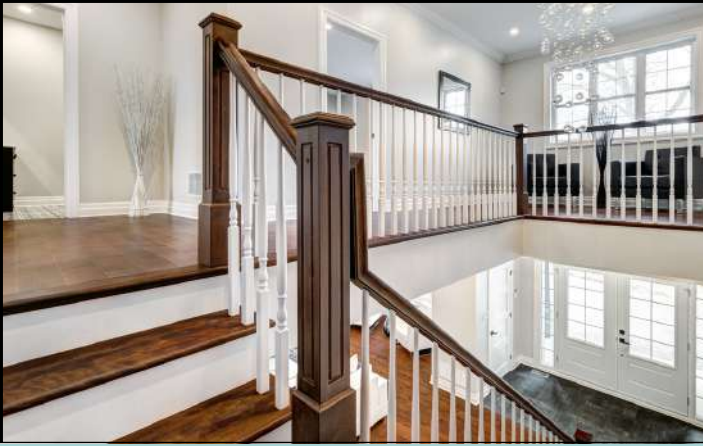

UNIQUE
- WOOD PRODUCTS -

Unique Wood Products reserves the right to make changes to the products listed without notice and without responsibility for existing items. Drawing and illustrations are nominal and may not be exact to scale.



www.uniquewoodproducts.com

 713.462.5045

 713.462.5086

 9915 Tanner Road, Houston TX 77041

 info@uniquewoodproducts.com

SINCE 1988